

WOOD BlocX

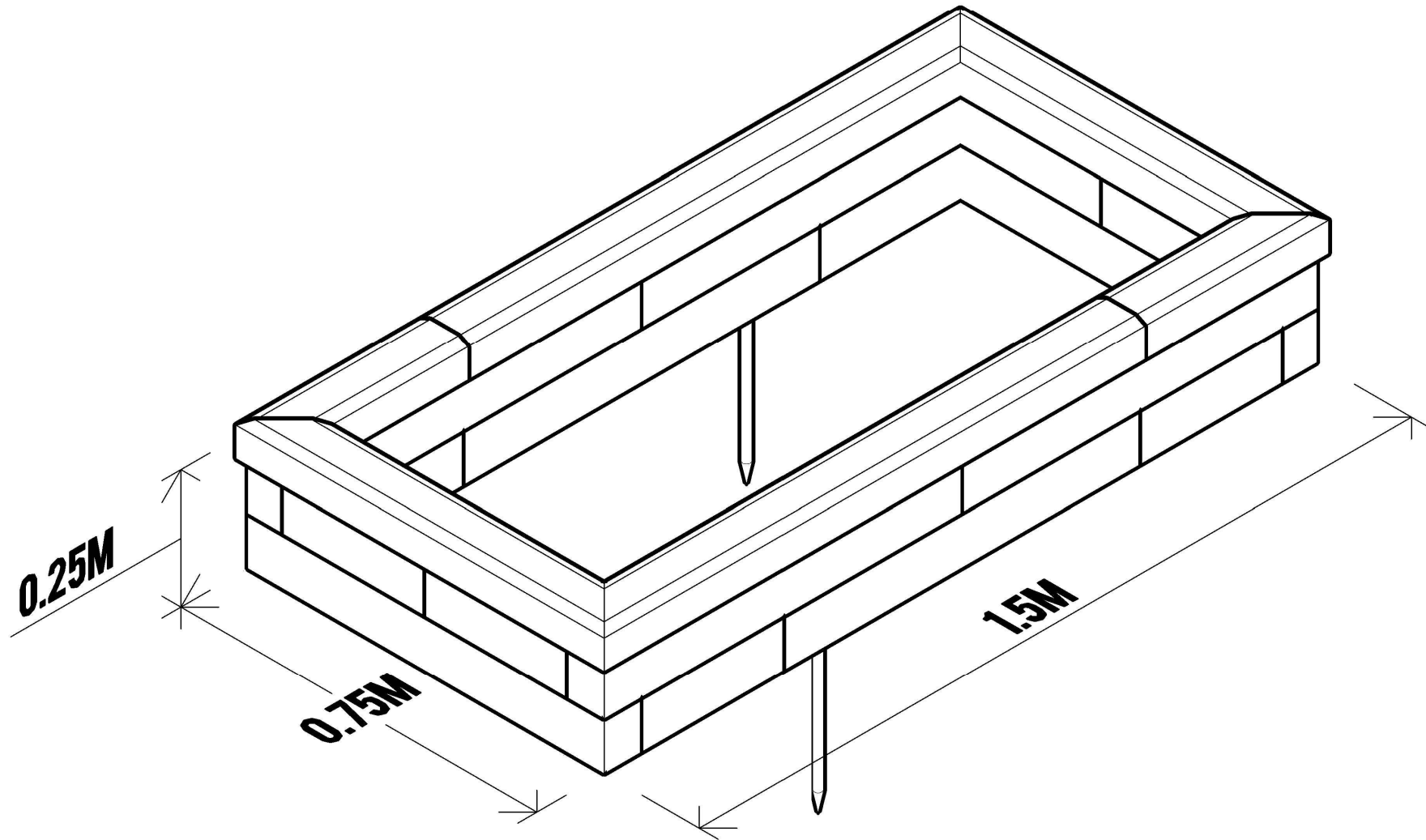

CUSTOMER NAME
SKU00015

DRAWING TITLE
COVER 3D

DESIGN VERSION
1.0

WOOD BlocX

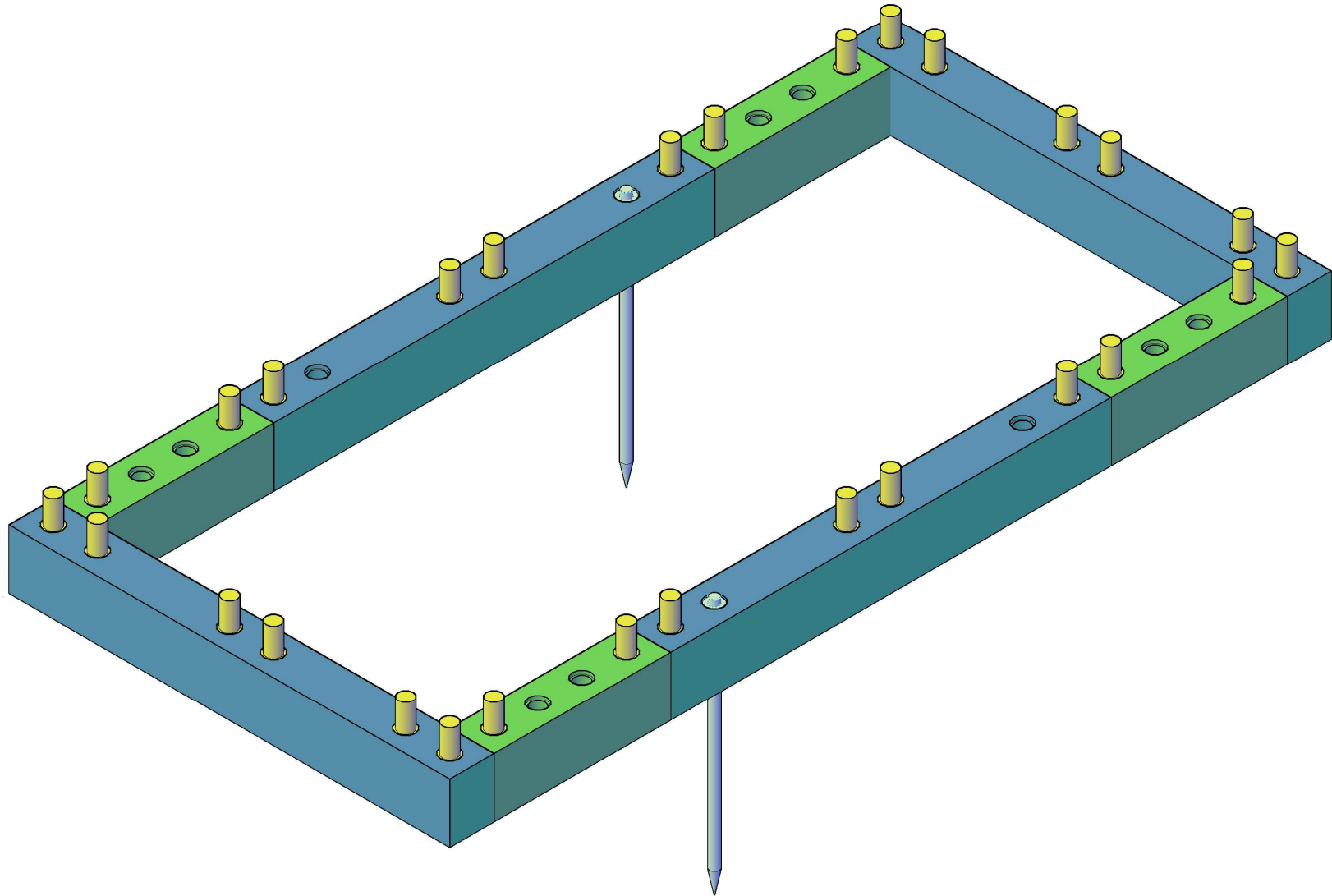

CUSTOMER NAME
SKU00015

DRAWING TITLE
LAYER01

DESIGN VERSION
1.0

WOOD BlocX

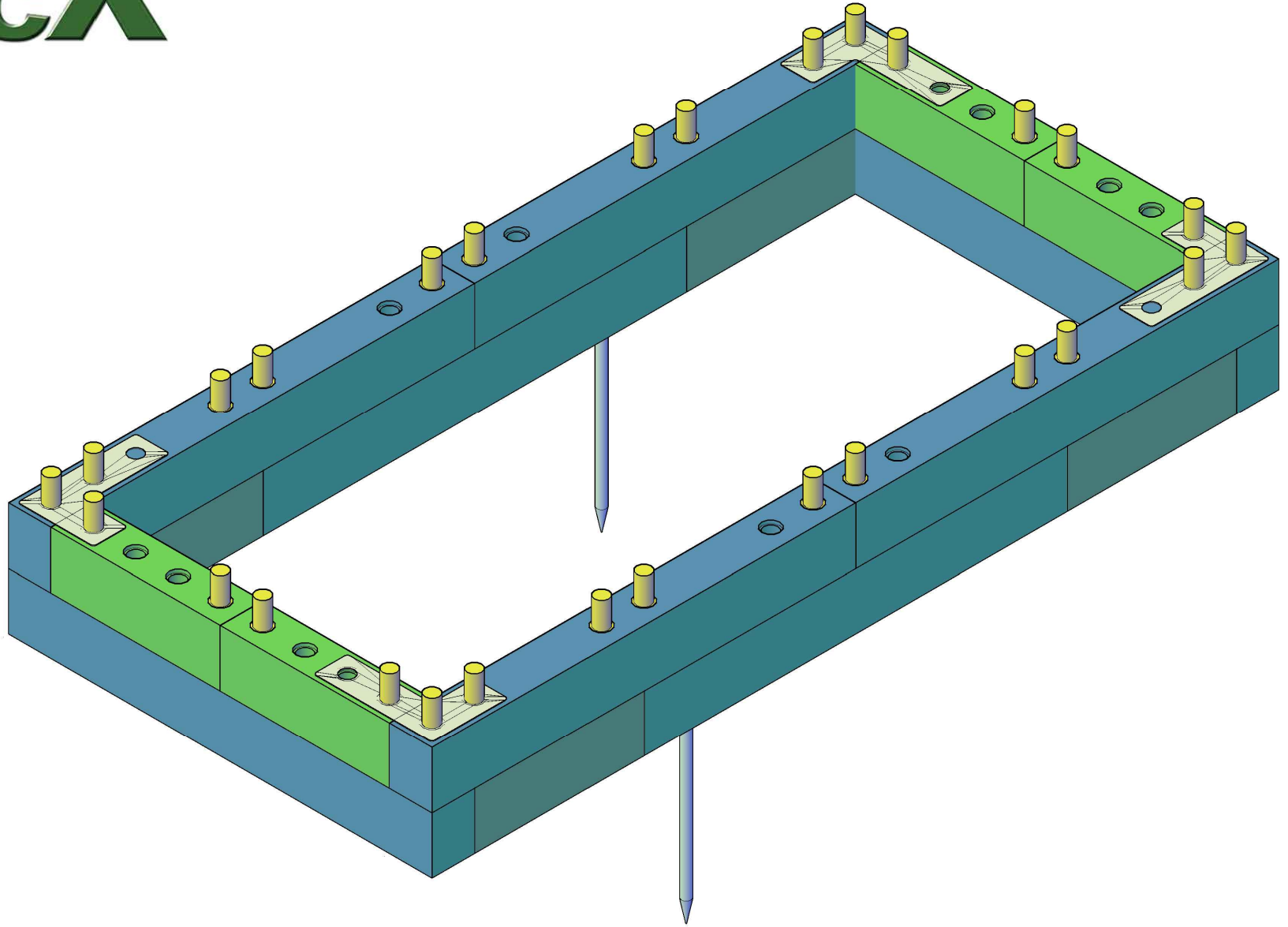

CUSTOMER NAME
SKU00015

DRAWING TITLE
LAYER02

DESIGN VERSION
1.0

WOOD BlocX

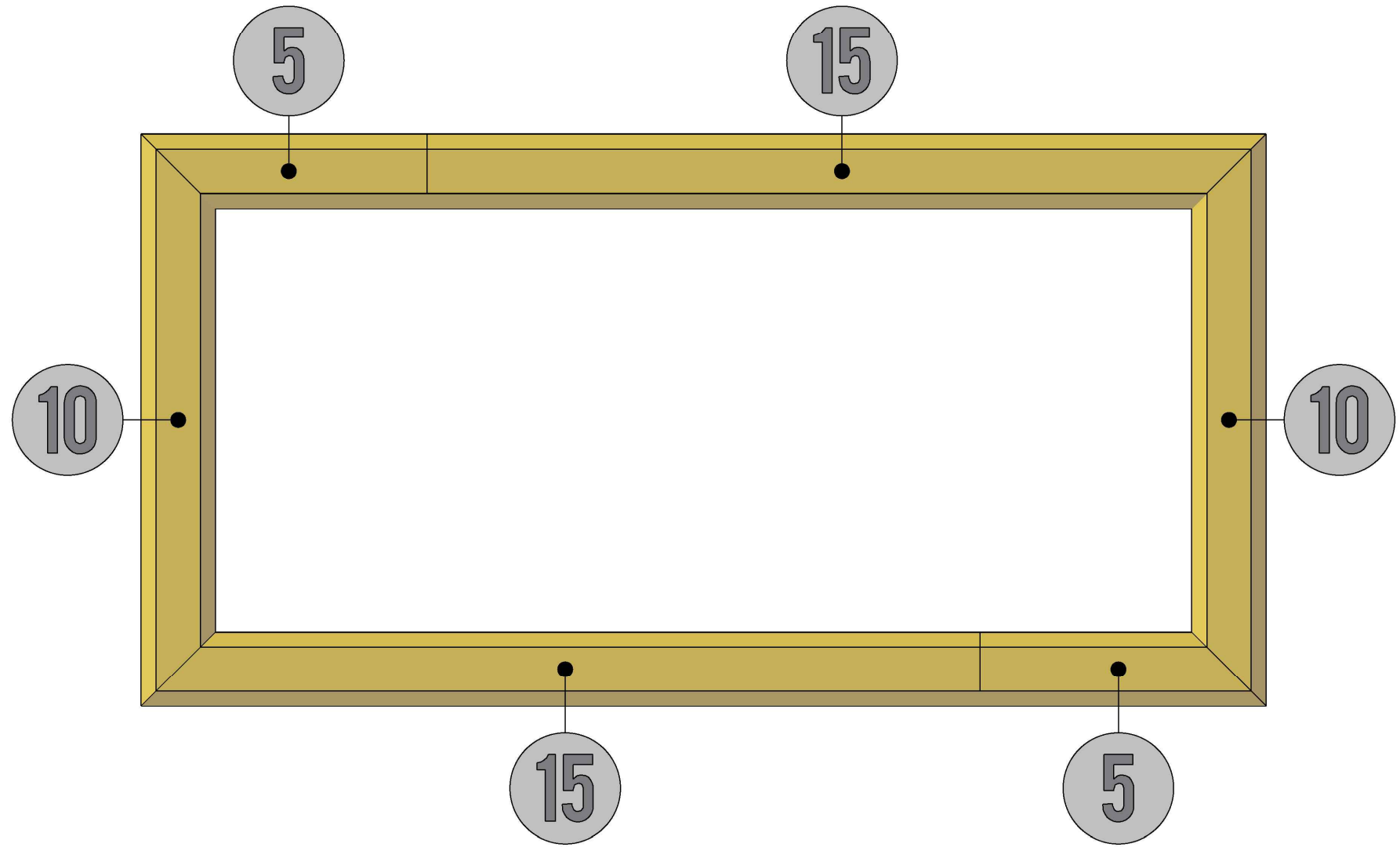

CUSTOMER NAME
SKU00015

DRAWING TITLE
CAPPINGPLAN

DESIGN VERSION
1.0

*NUMBERS REPRESENT NUMBER OF HOLES INCAPPING

WOOD BlocX

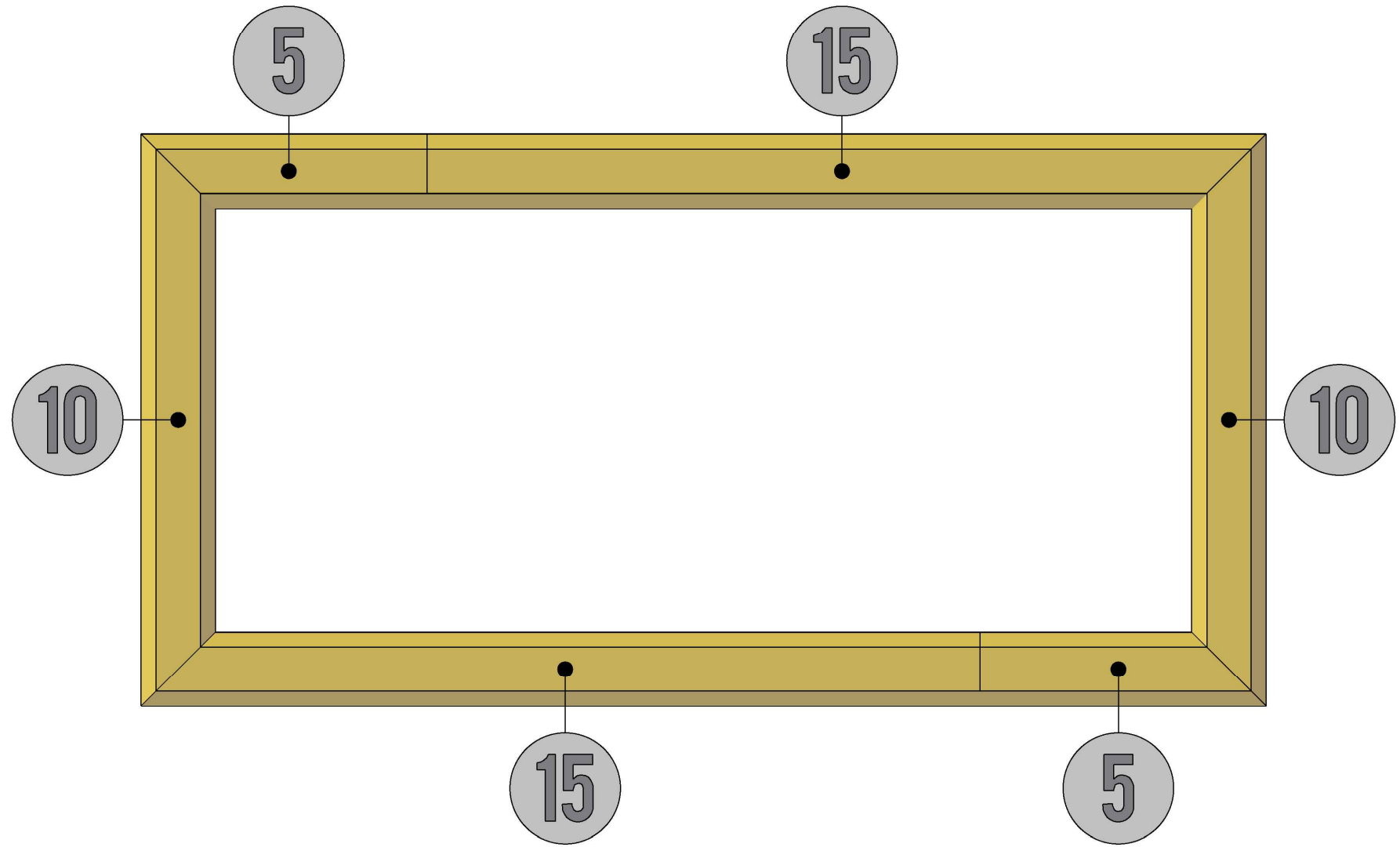

CUSTOMER NAME
SKU00015

DRAWING TITLE
CAPPINGPLAN2

DESIGN VERSION
1.0

*NUMBERS REPRESENT NUMBER OF HOLES INCAPPING