

# WOOD BlocX

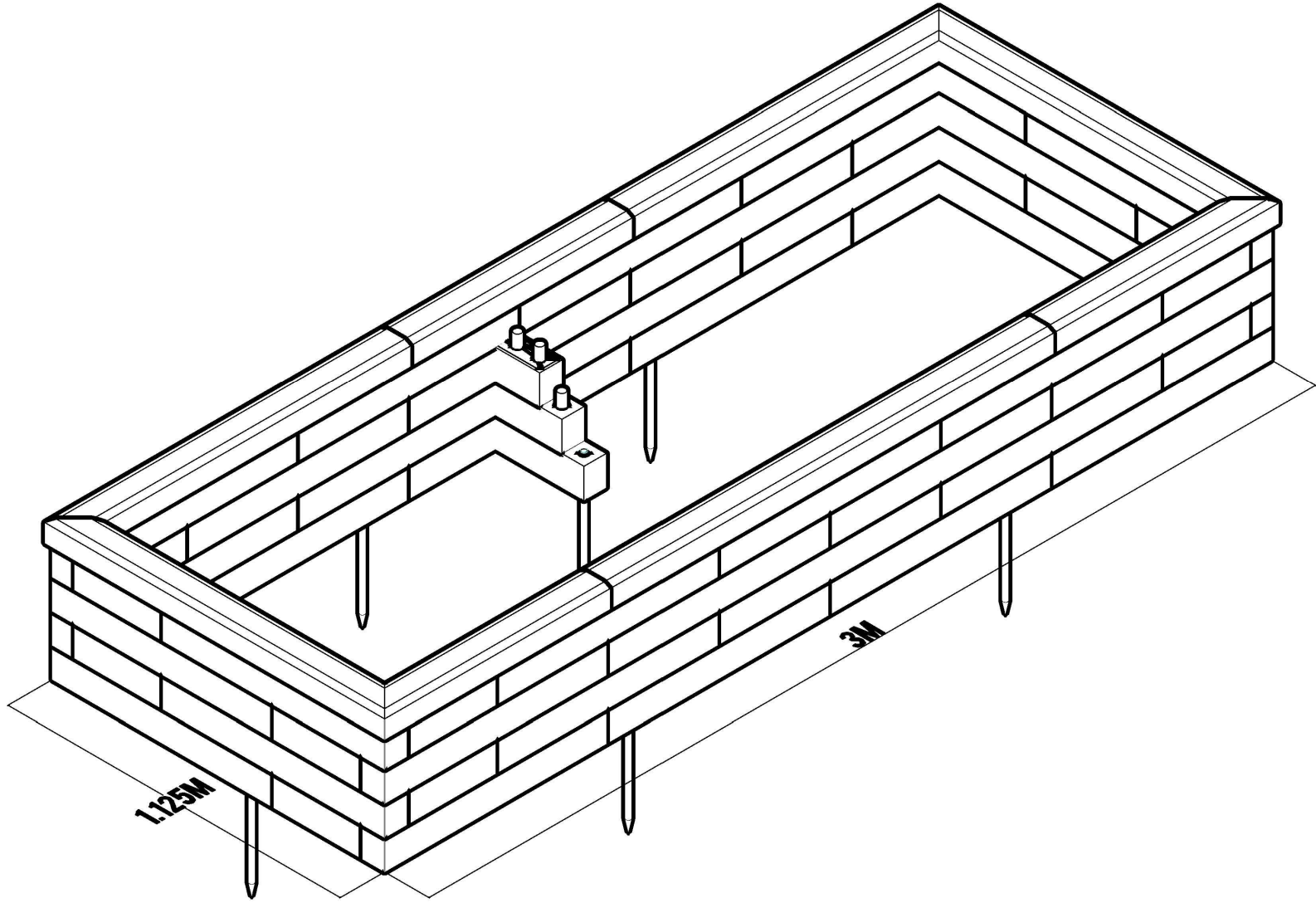

CUSTOMER NAME

5.DWGMX----MX----M

DRAWING TITLE

COVER 3D

DESIGN VERSION

# WOOD BlocX

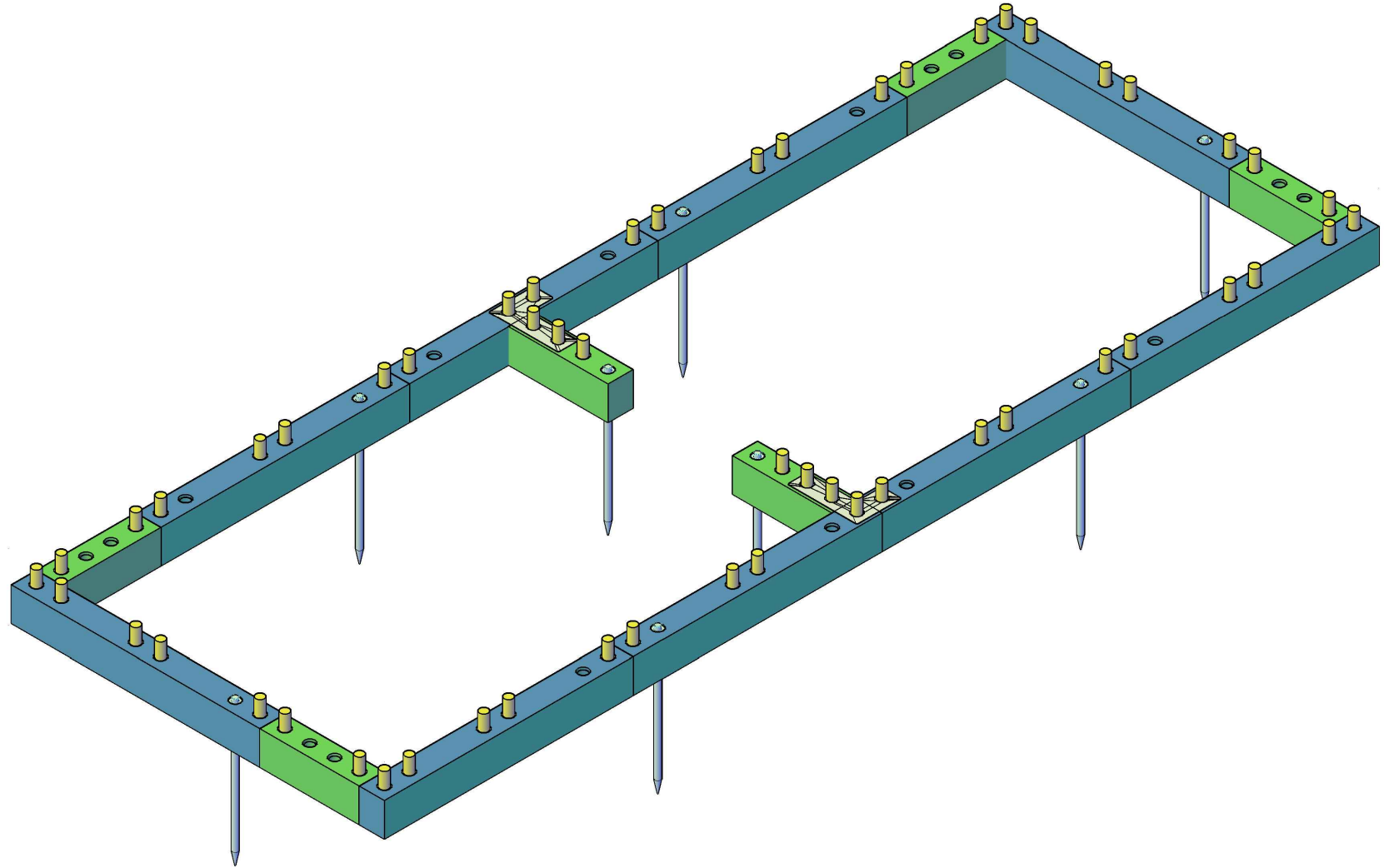

CUSTOMER NAME

DRAWING TITLE

DESIGN VERSION

5.DWGMX----MX----M

LAYER1

# WOOD BlocX

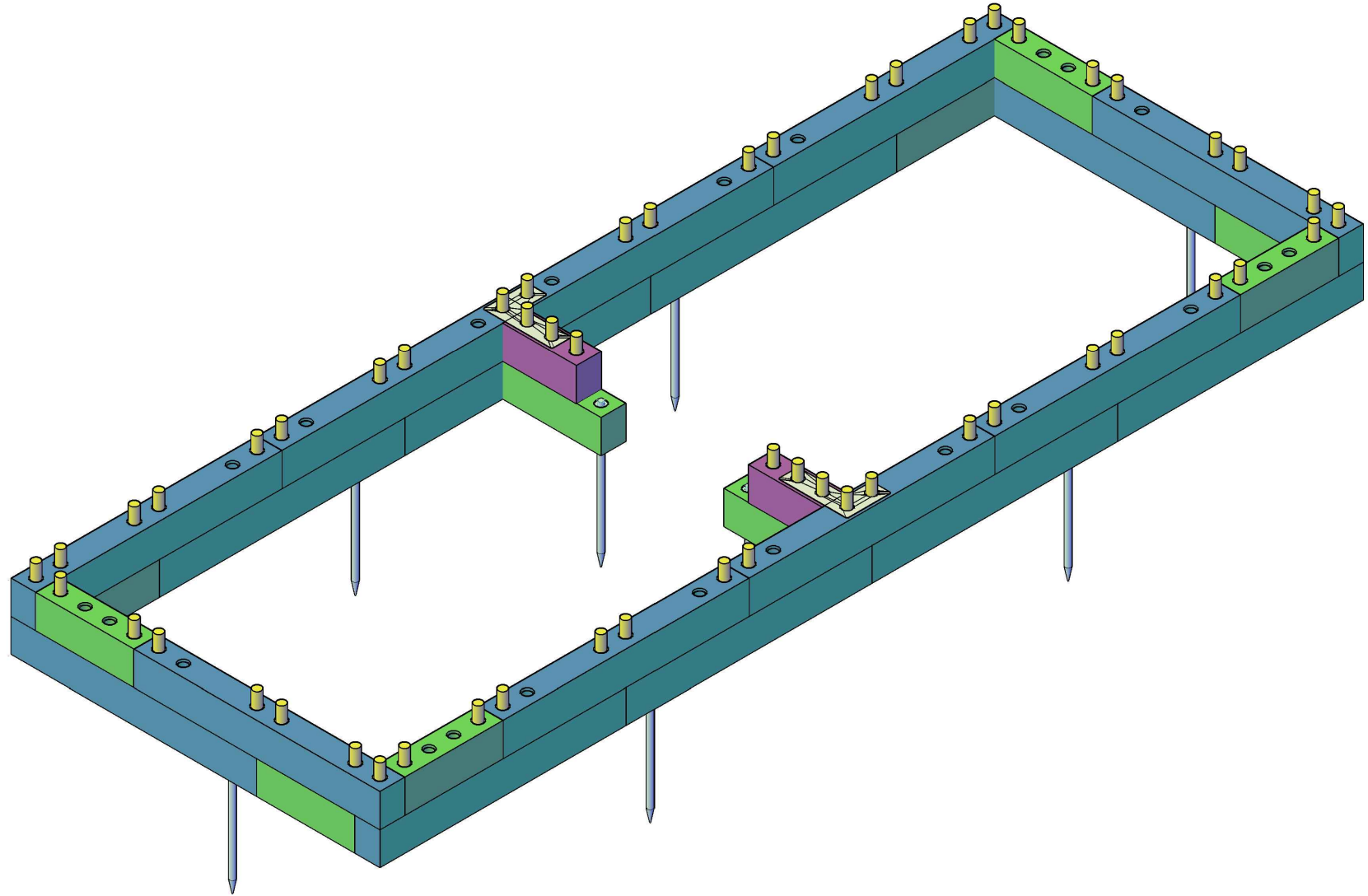

CUSTOMER NAME

DRAWING TITLE

DESIGN VERSION

5.DWGMX----MX----M

LAYER2

# WOOD BlocX

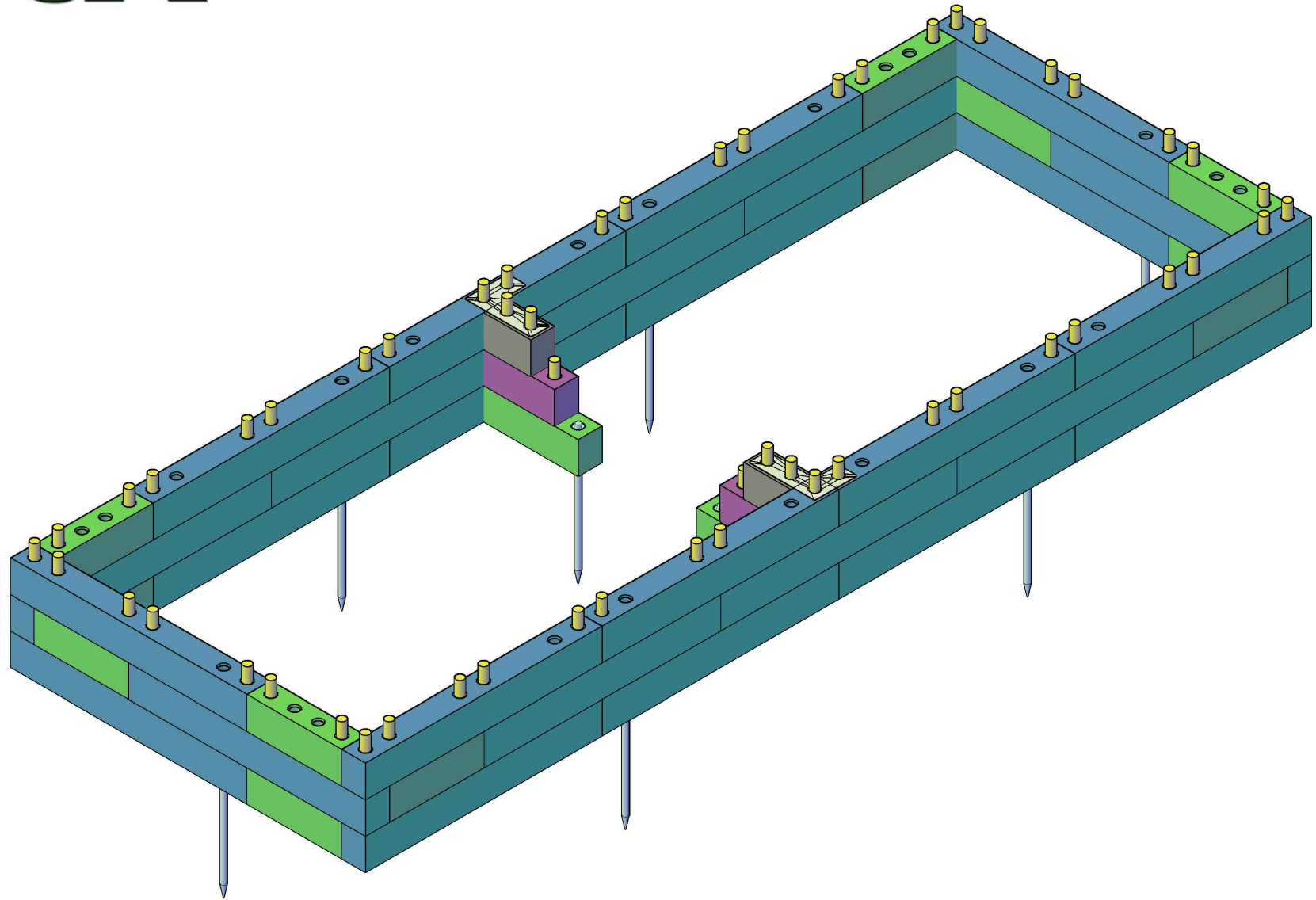

CUSTOMER NAME

DRAWING TITLE

DESIGN VERSION

5.DWGMX----MX----M

LAYER 3

# WOOD BlocX

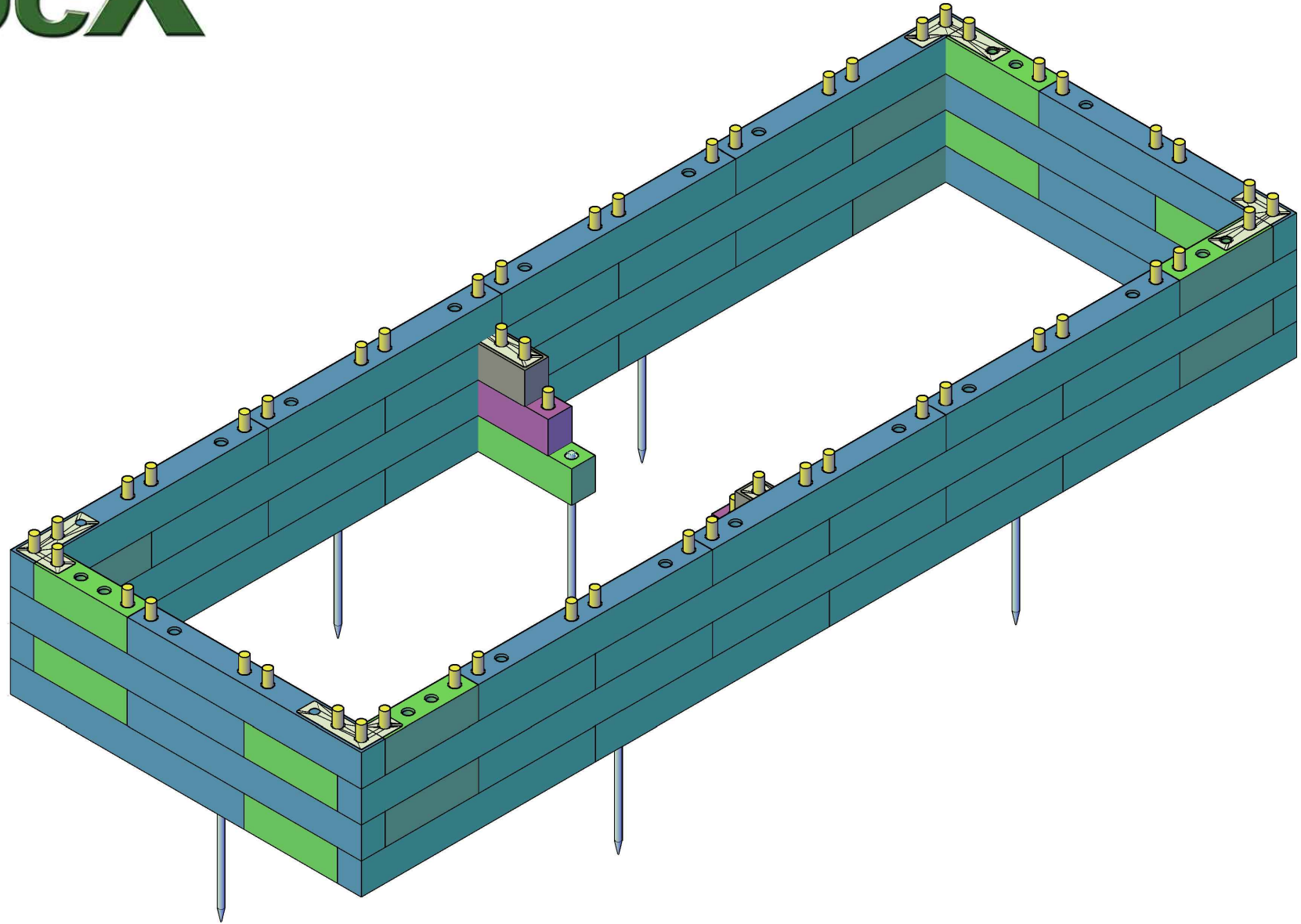

CUSTOMER NAME

DRAWING TITLE

DESIGN VERSION

5.DWGMX----MX----M

LAYER 4

# WOOD BlocX

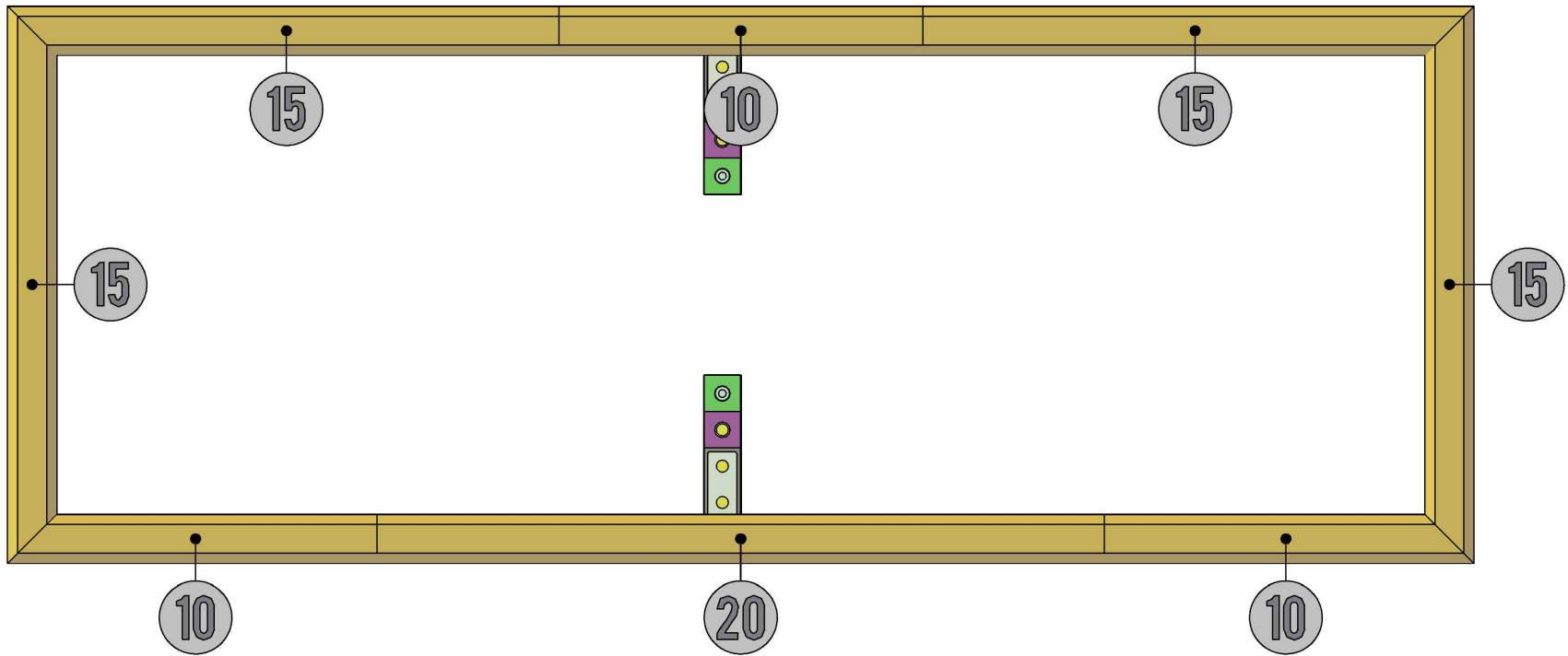

CUSTOMER NAME

DRAWING TITLE

DESIGN VERSION

\*NUMBERS REPRESENT NUMBER OF HOLES IN CAPPING

5.DWGMX----MX----M

CAPPING PLAN

# WOOD BlocX

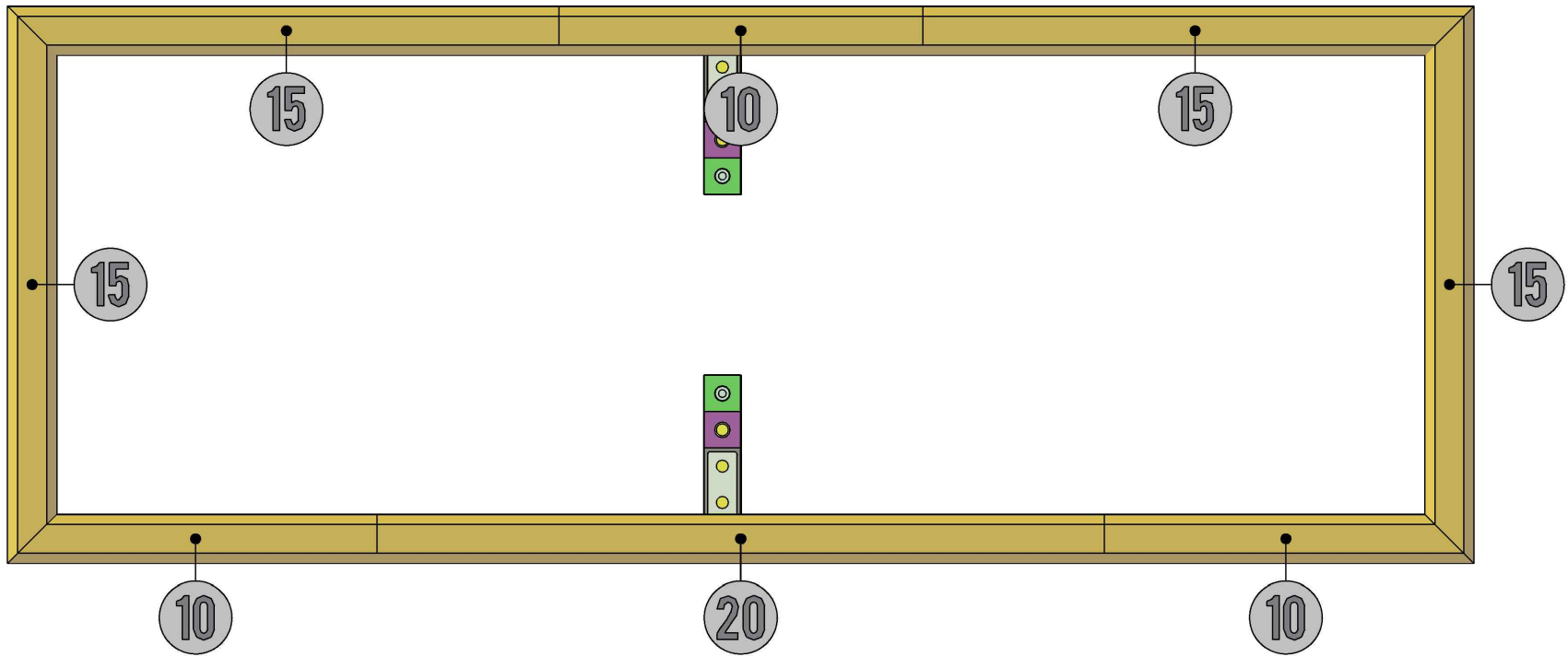

CUSTOMER NAME

DRAWING TITLE

DESIGN VERSION

\*NUMBERS REPRESENT NUMBER OF HOLES IN CAPPING

5.DWGMX----MX----M

CAPPING PLAN