

WOOD BlocX

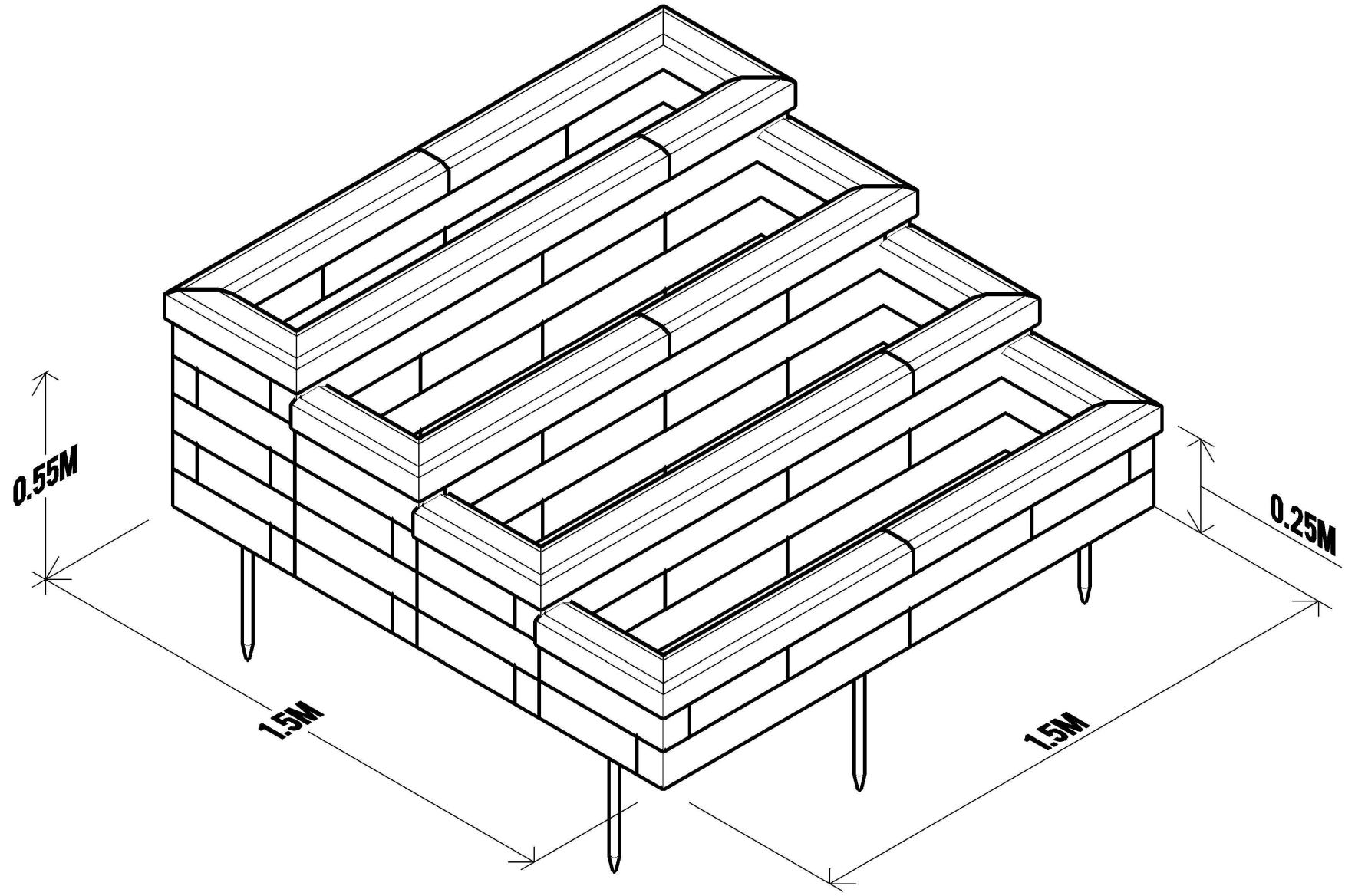

CUSTOMER NAME

3.DWGMX----MX----M

DRAWING TITLE

COVER 3D

DESIGN VERSION

WOOD BlocX

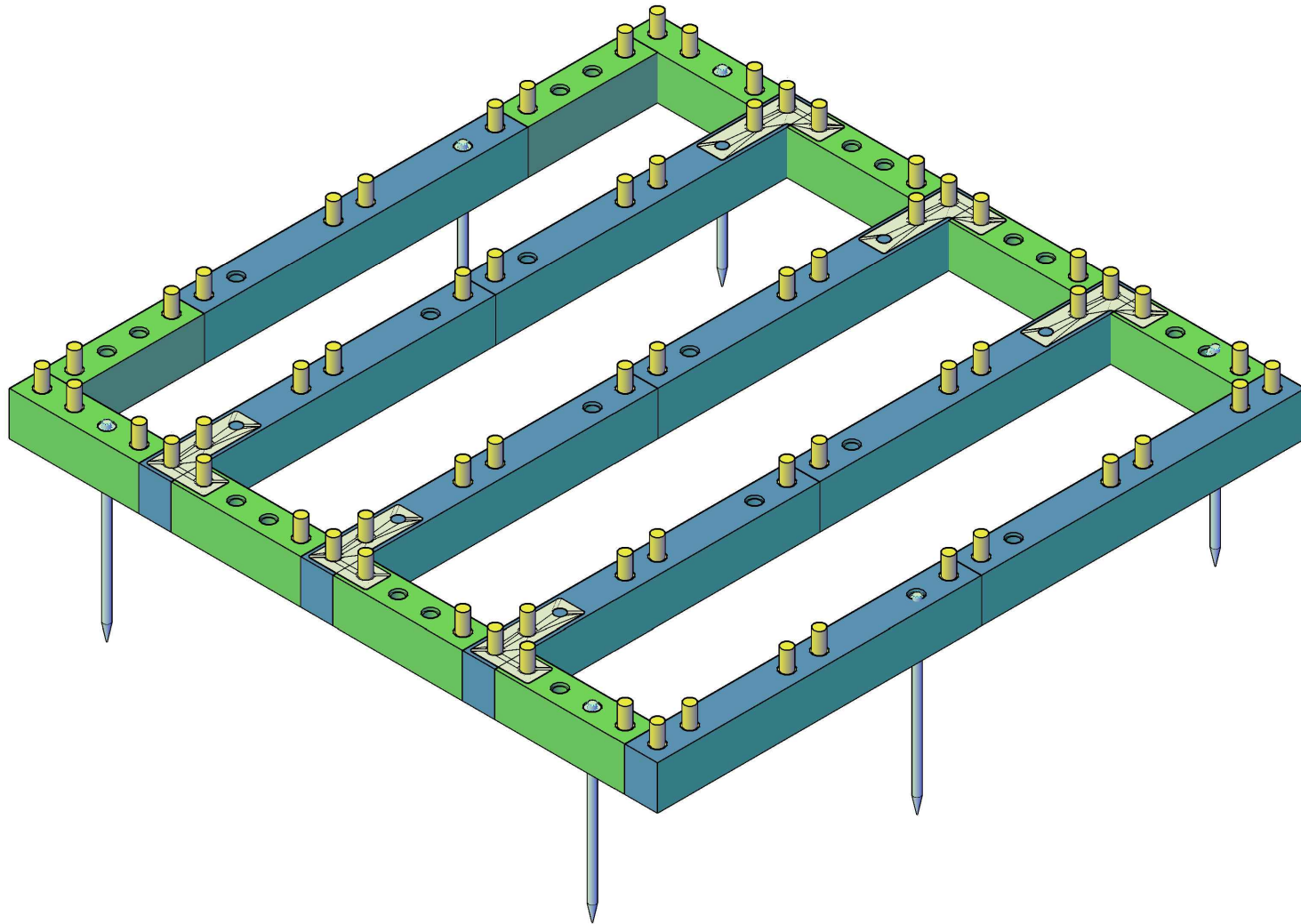

CUSTOMER NAME

DRAWING TITLE

DESIGN VERSION

3.DWGMX----MX----M

LAYER1

WOOD BlocX

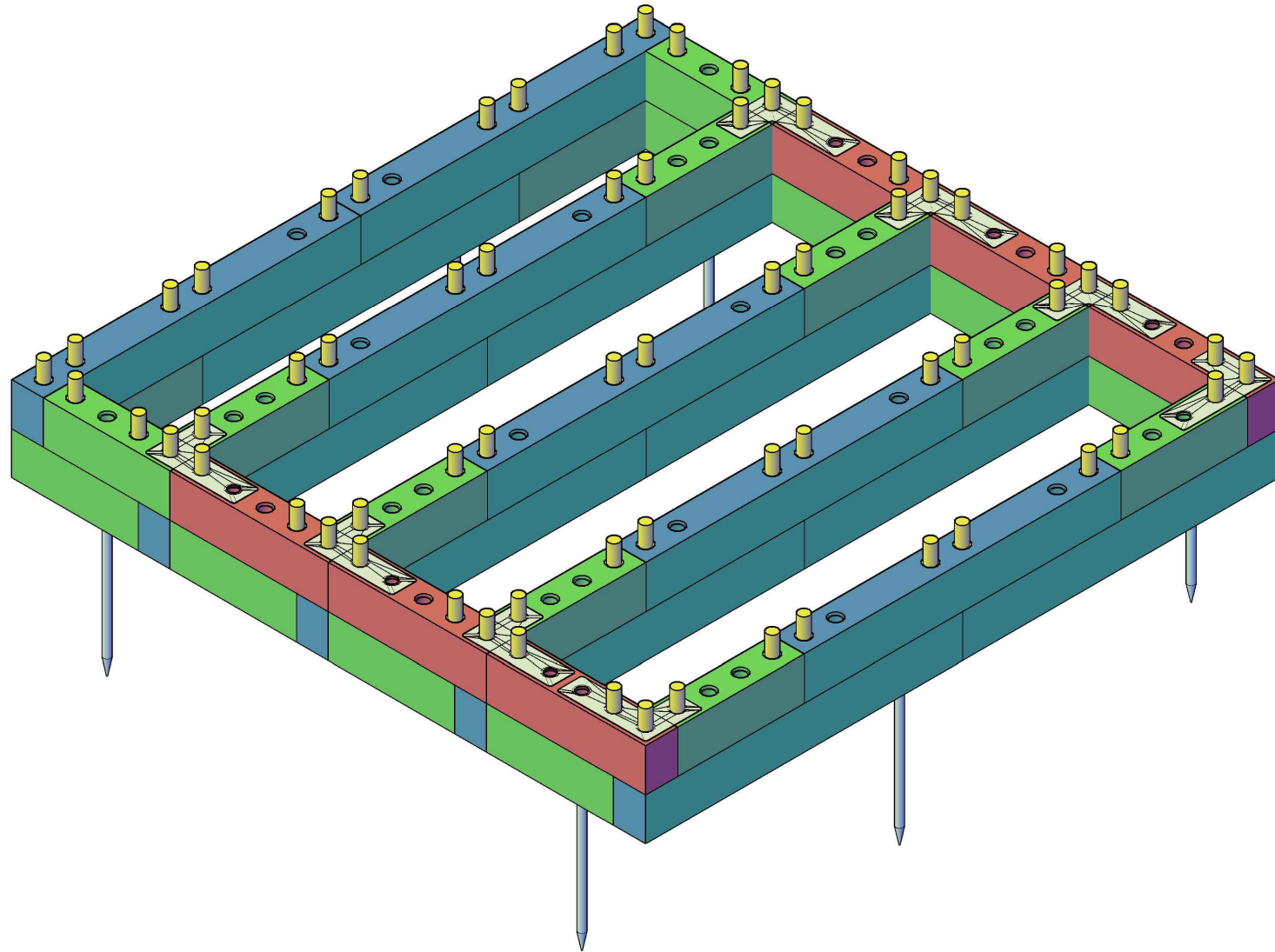

CUSTOMER NAME

DRAWING TITLE

DESIGN VERSION

3.DWGMX----MX----M

LAYER2

WOOD BlocX

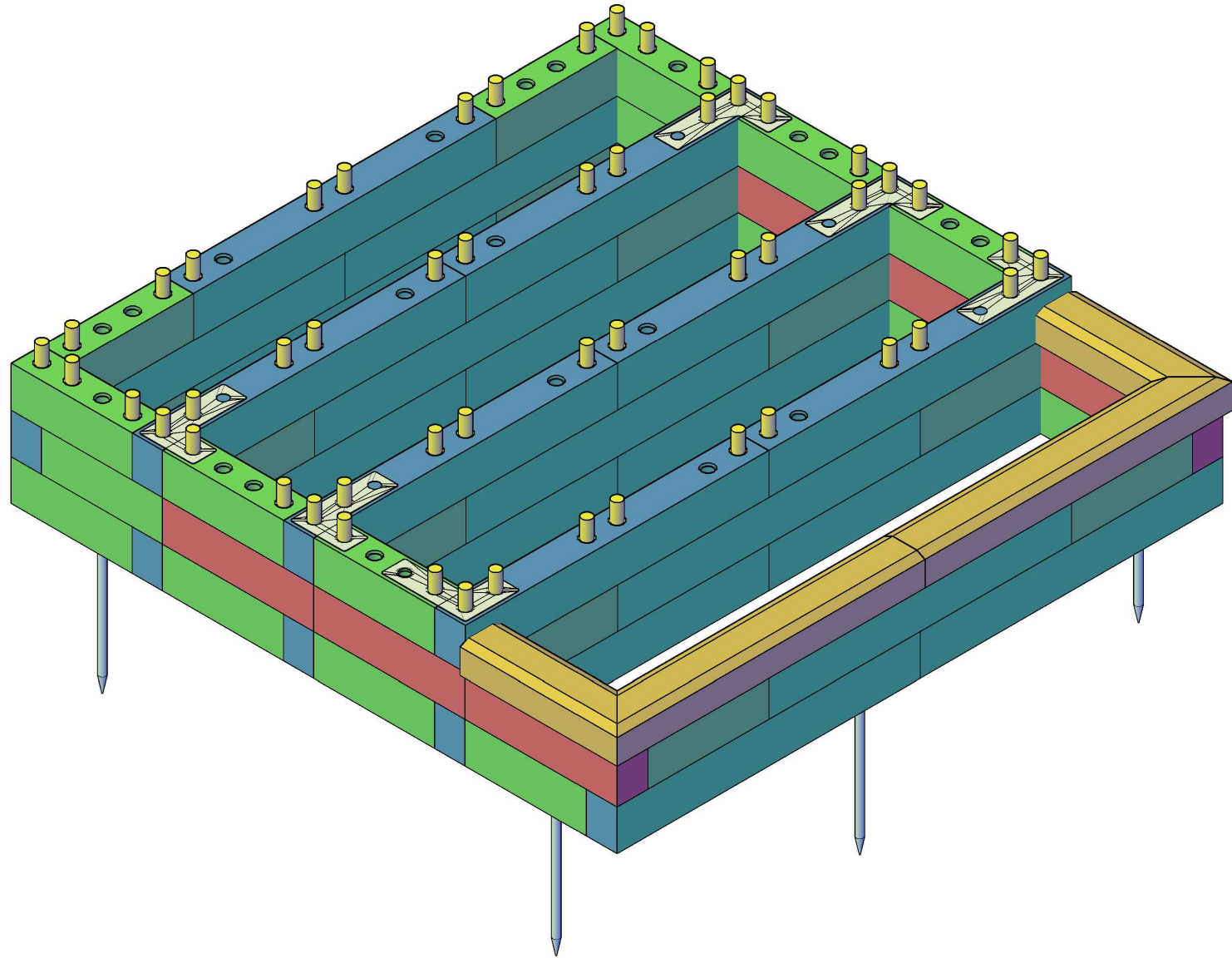

CUSTOMER NAME

DRAWING TITLE

DESIGN VERSION

3.DWGMX----MX----M

LAYER 3

WOOD BlocX

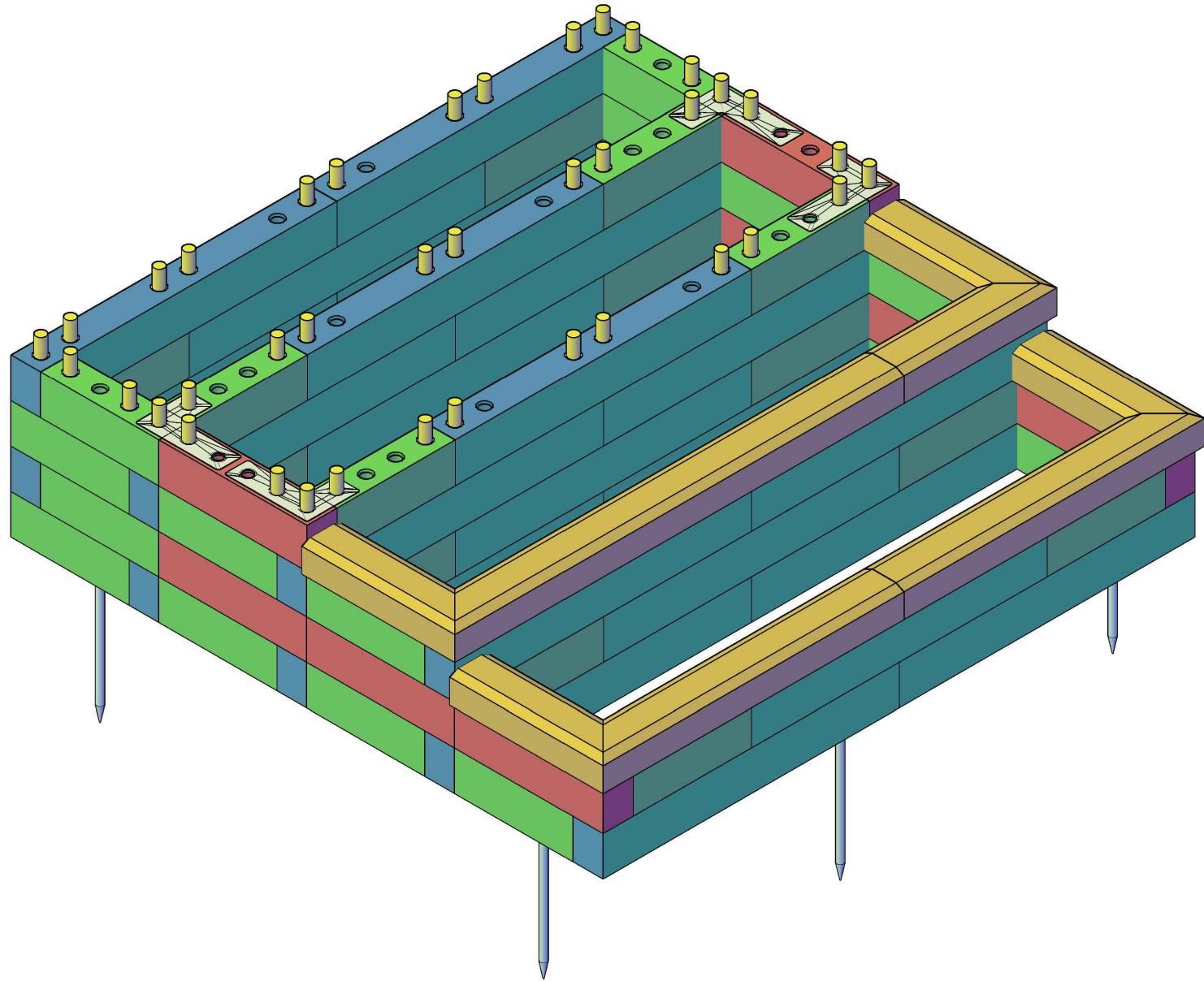

CUSTOMER NAME

DRAWING TITLE

DESIGN VERSION

3.DWGMX----MX----M

LAYER 4

WOOD BlocX

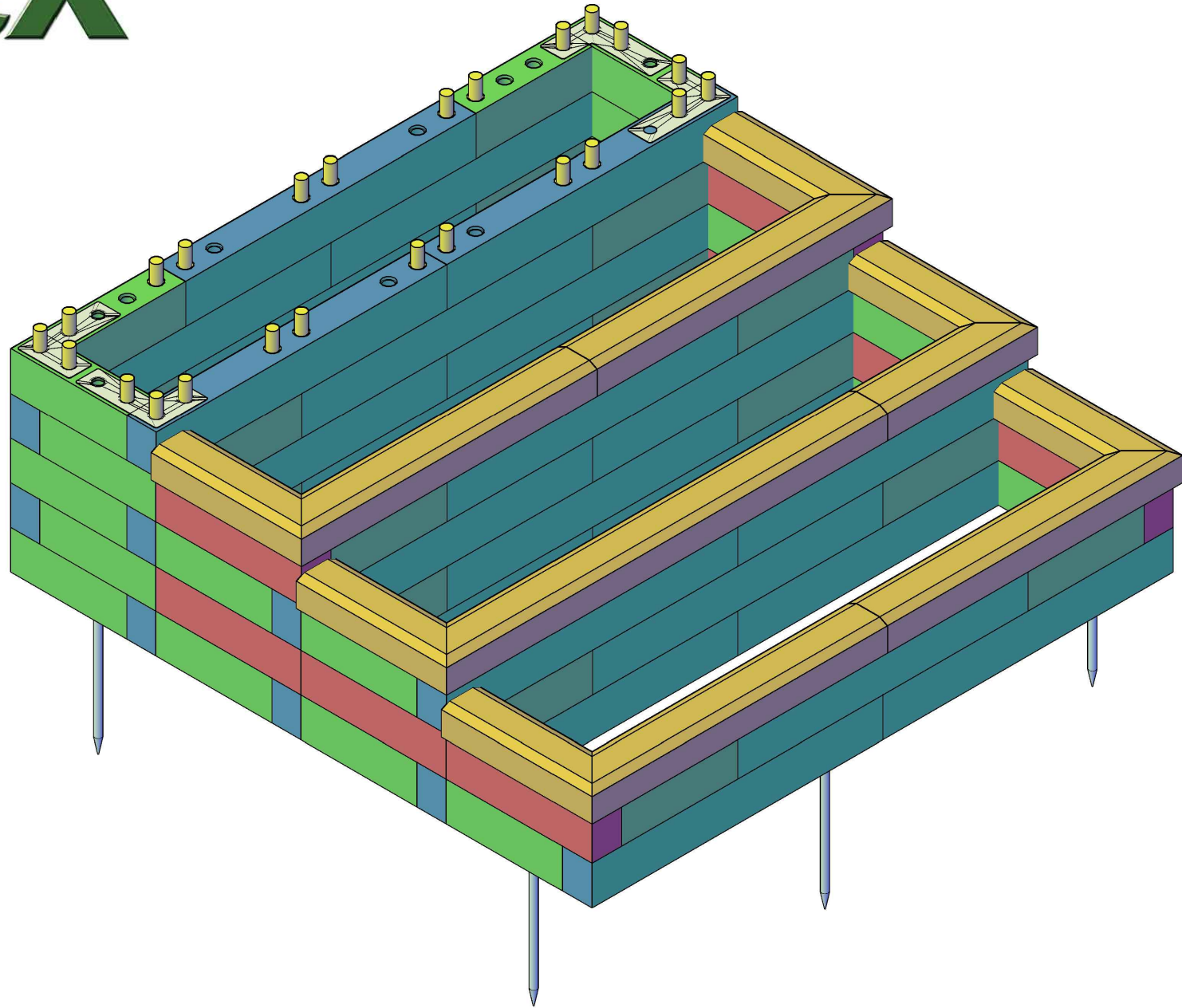

CUSTOMER NAME

DRAWING TITLE

DESIGN VERSION

3.DWGMX----MX----M

LAYER5

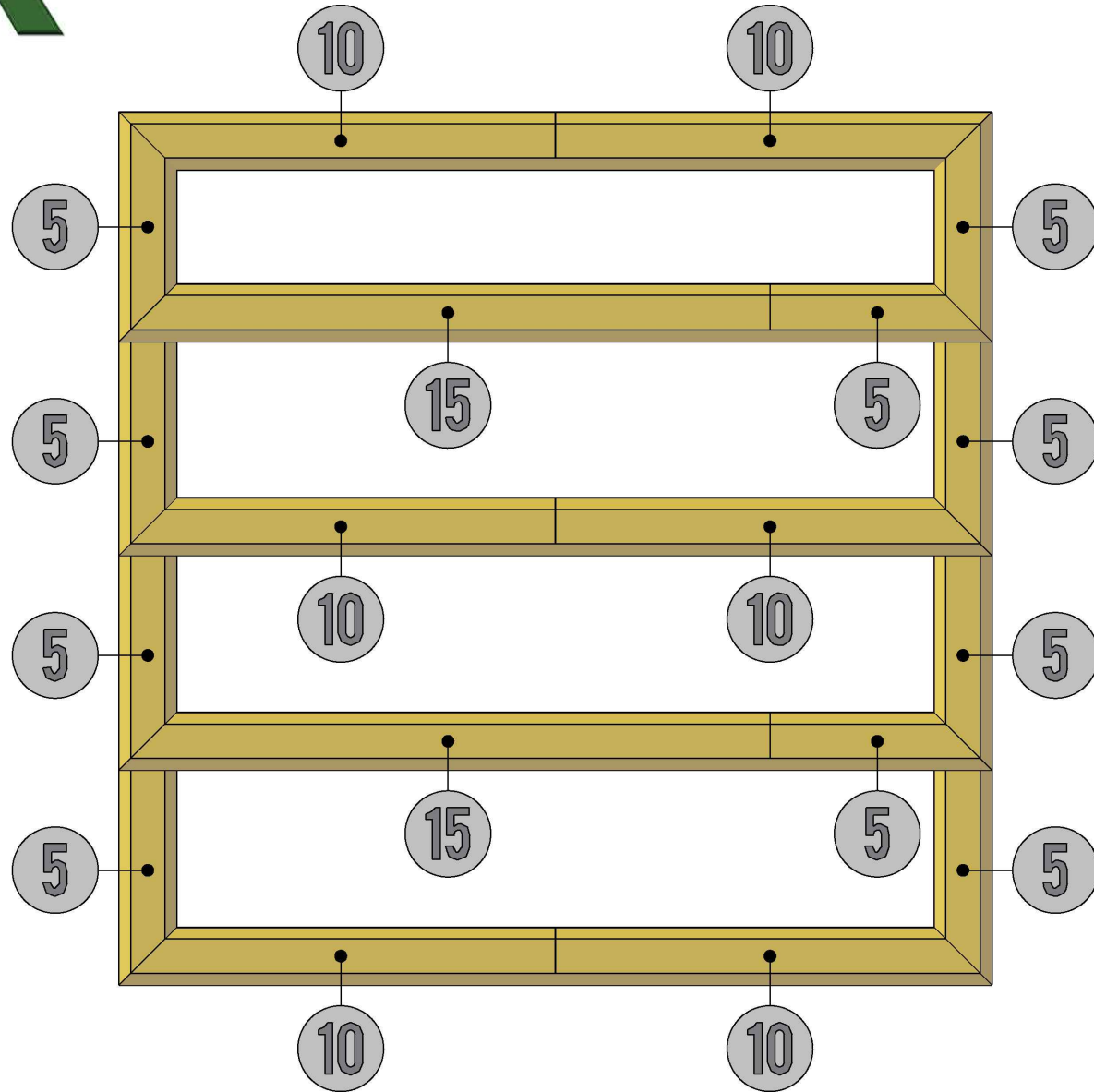

CUSTOMER NAME

DRAWING TITLE

DESIGN VERSION

*NUMBERS REPRESENT NUMBER OF HOLES INCAPPING

3.DWGMX----MX----M

CAPPINGPLAN

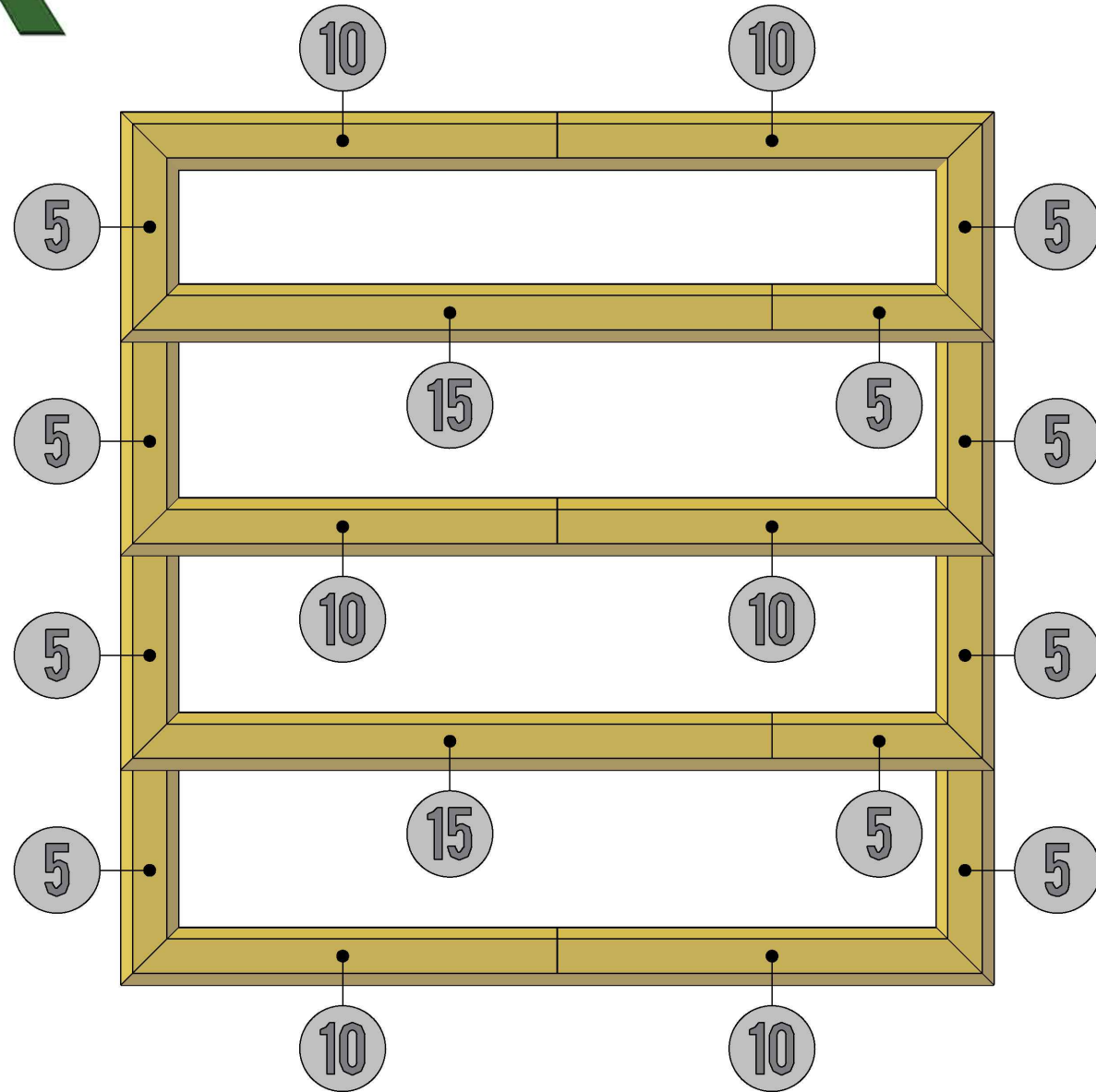

CUSTOMER NAME

DRAWING TITLE

DESIGN VERSION

*NUMBERS REPRESENT NUMBER OF HOLES INCAPPING

3.DWGMX----MX----M

CAPPINGPLAN