

WOOD BlocX

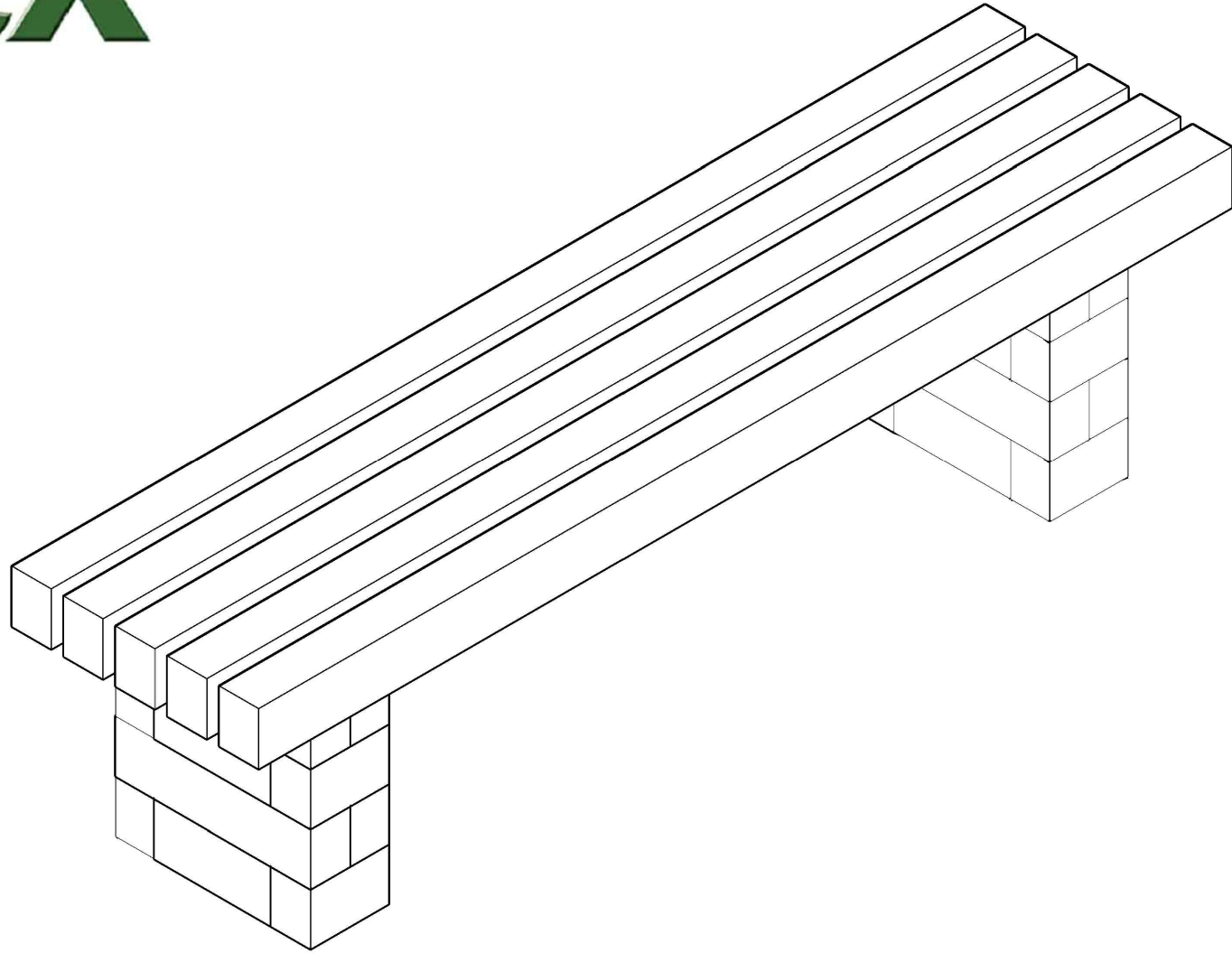

CUSTOMER NAME

BESPOKE

DRAWING TITLE

COVER 3D

DESIGN VERSION

WOOD BlocX

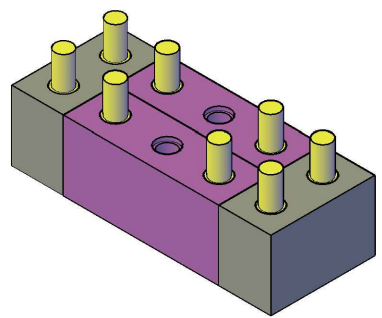
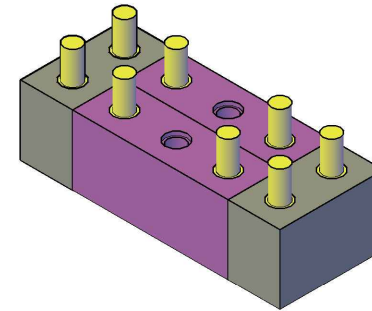

WOOD BlocX

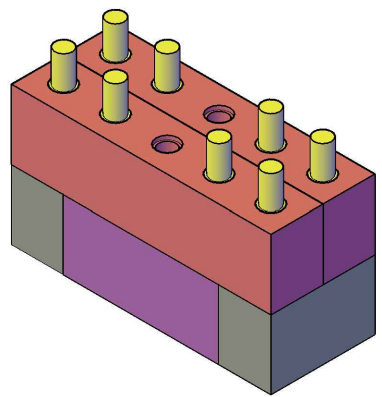
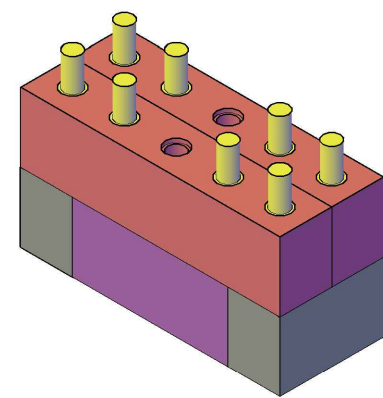

WOOD BlocX

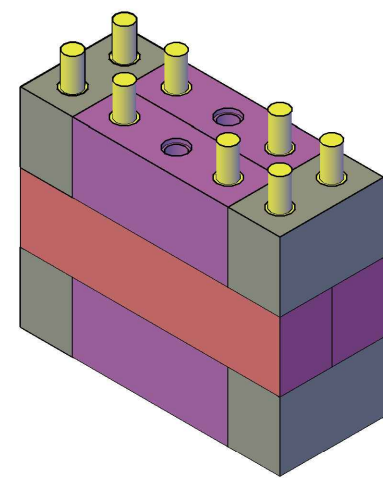
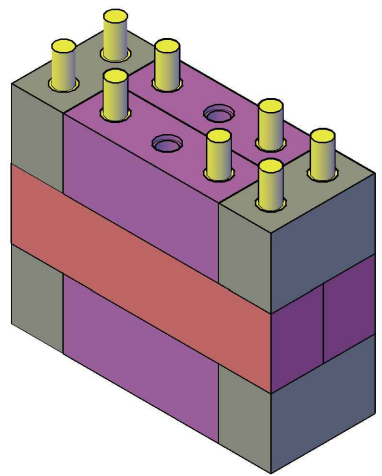

CUSTOMER NAME

BESPOKE

DRAWING TITLE

LAYER3

DESIGN VERSION

WOOD BlocX

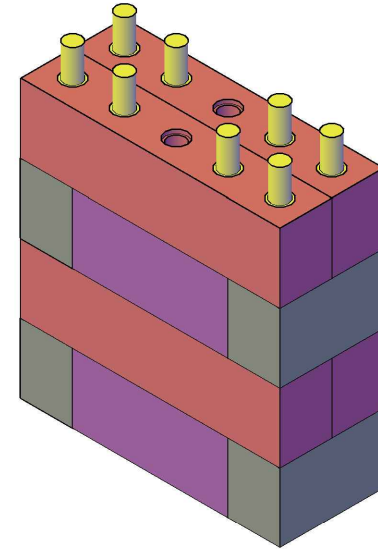
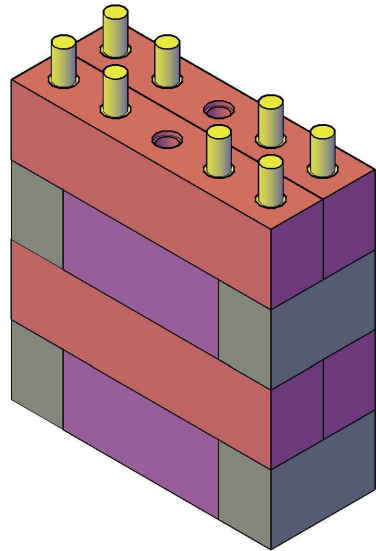

CUSTOMER NAME

BESPOKE

DRAWING TITLE

LAYER 4

DESIGN VERSION

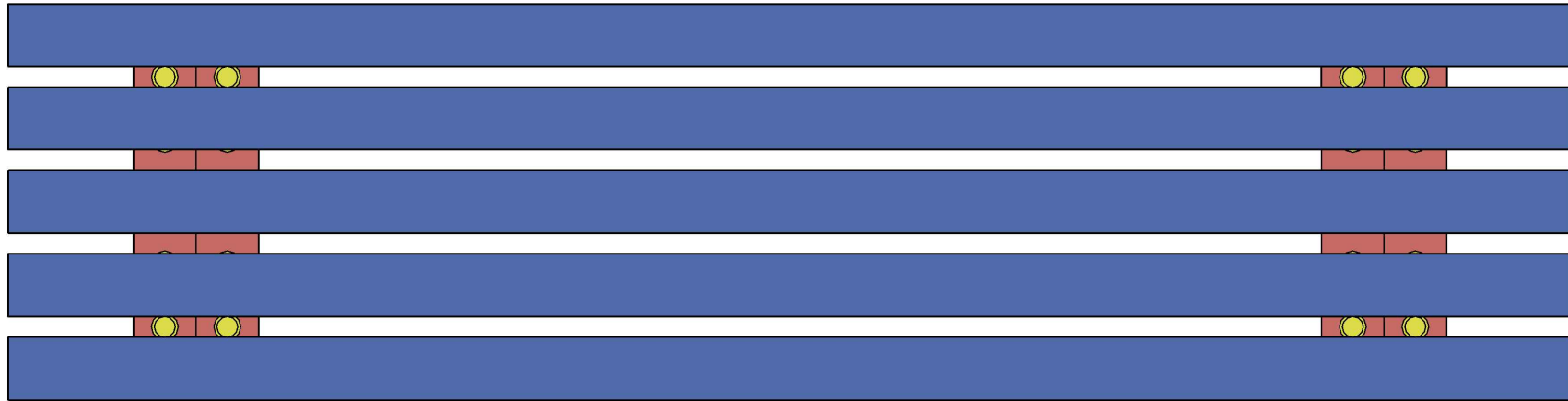

CUSTOMER NAME

BESPOKE

DRAWING TITLE

CAPPINGPLAN

DESIGN VERSION

*NUMBERS REPRESENT NUMBER OF HOLES INCAPPING

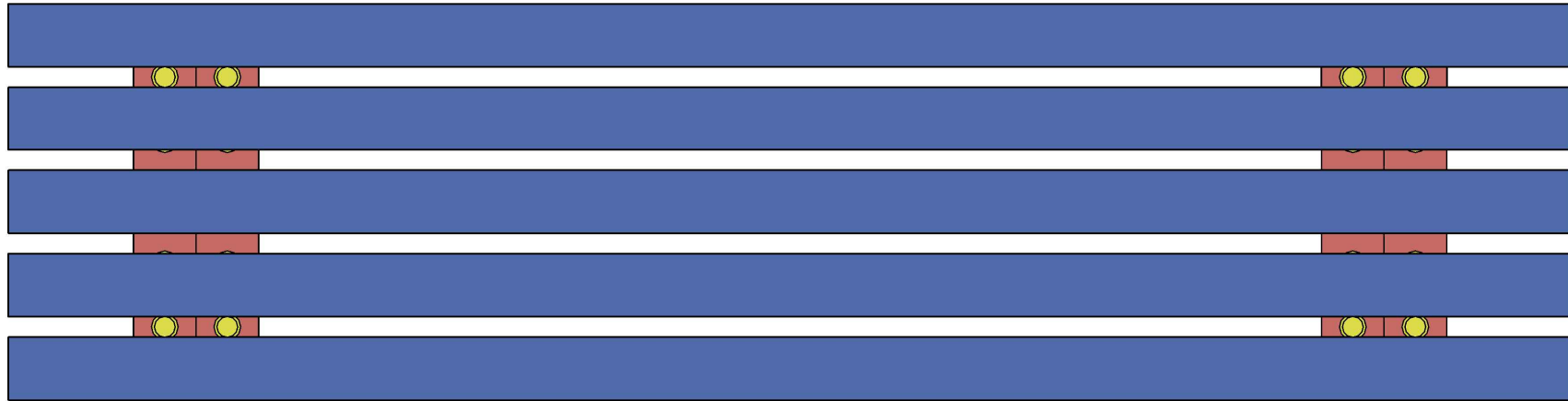

CUSTOMER NAME

BESPOKE

DRAWING TITLE

CAPPINGPLAN

DESIGN VERSION

*NUMBERS REPRESENT NUMBER OF HOLES IN CAPPING