

# WOOD BlocX

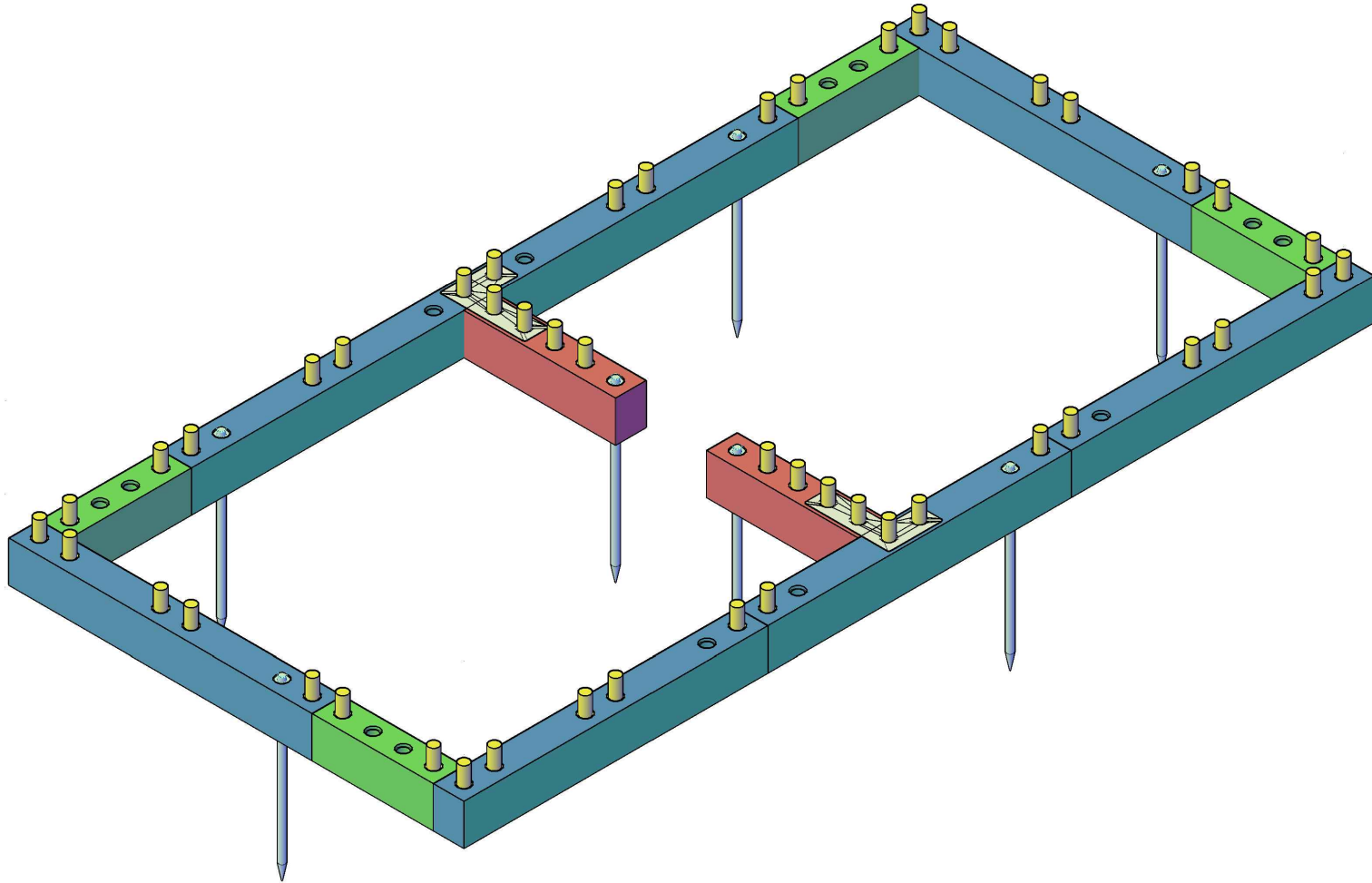

# WOOD BlocX

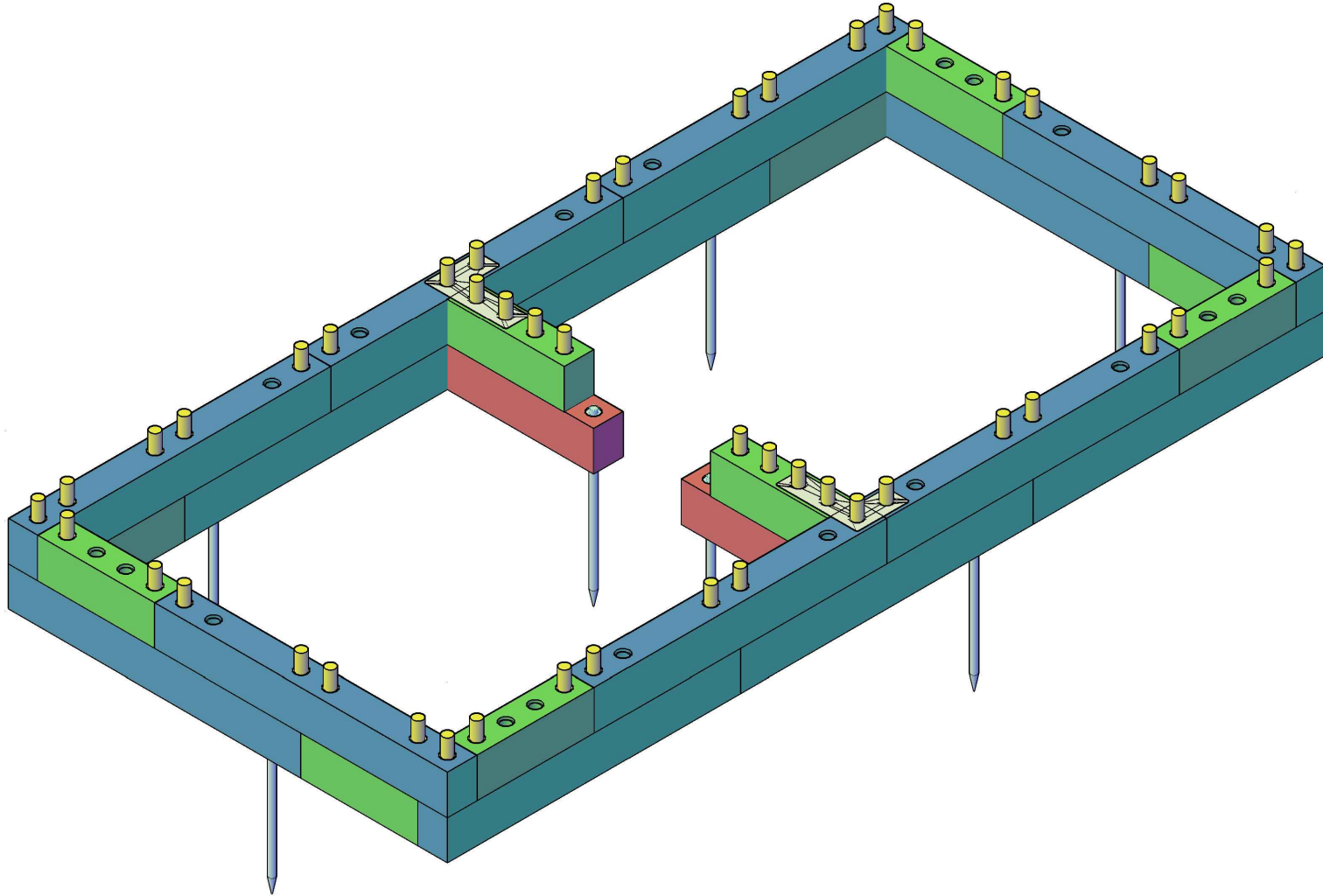

# WOOD BlocX

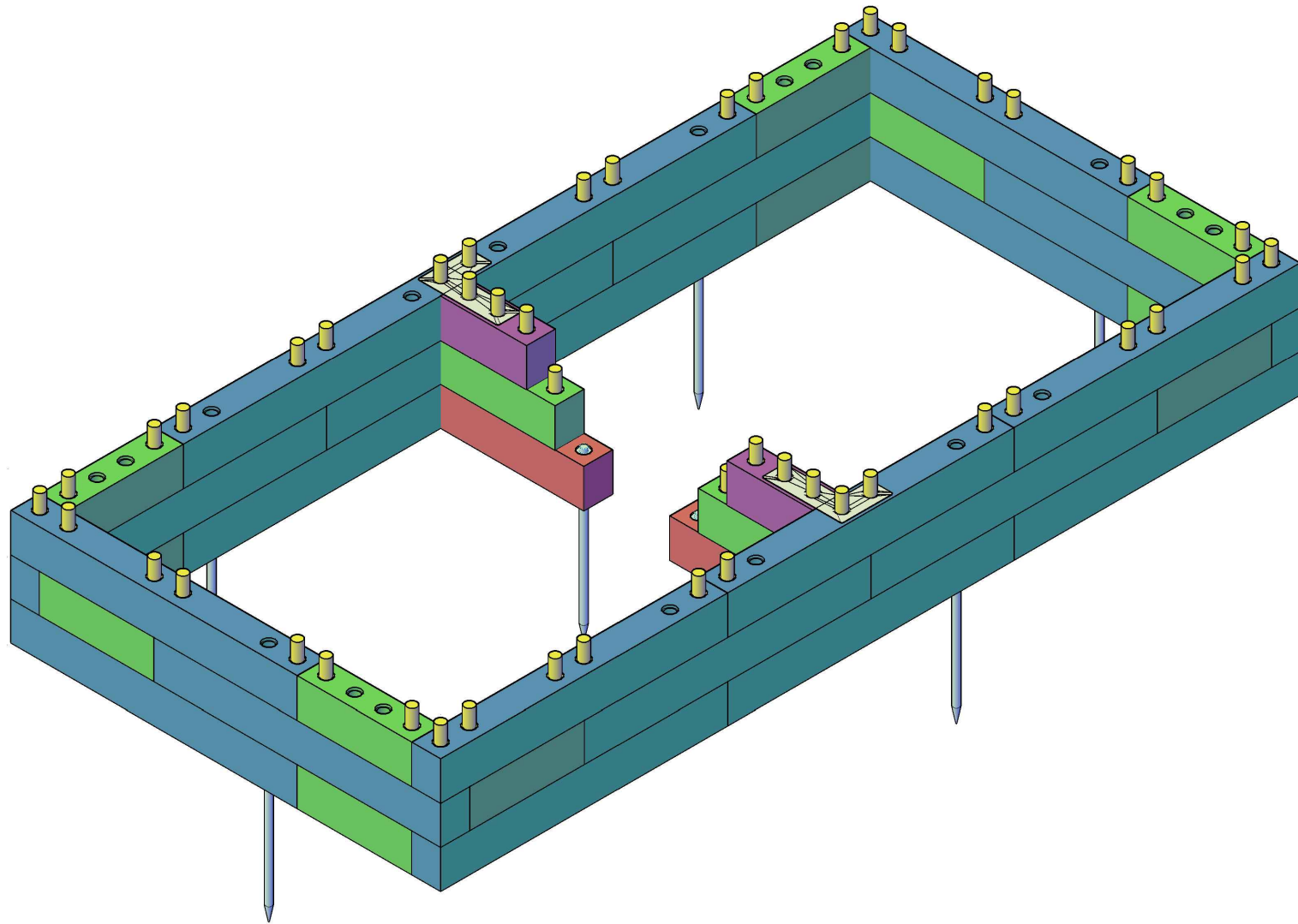

# WOOD BlocX

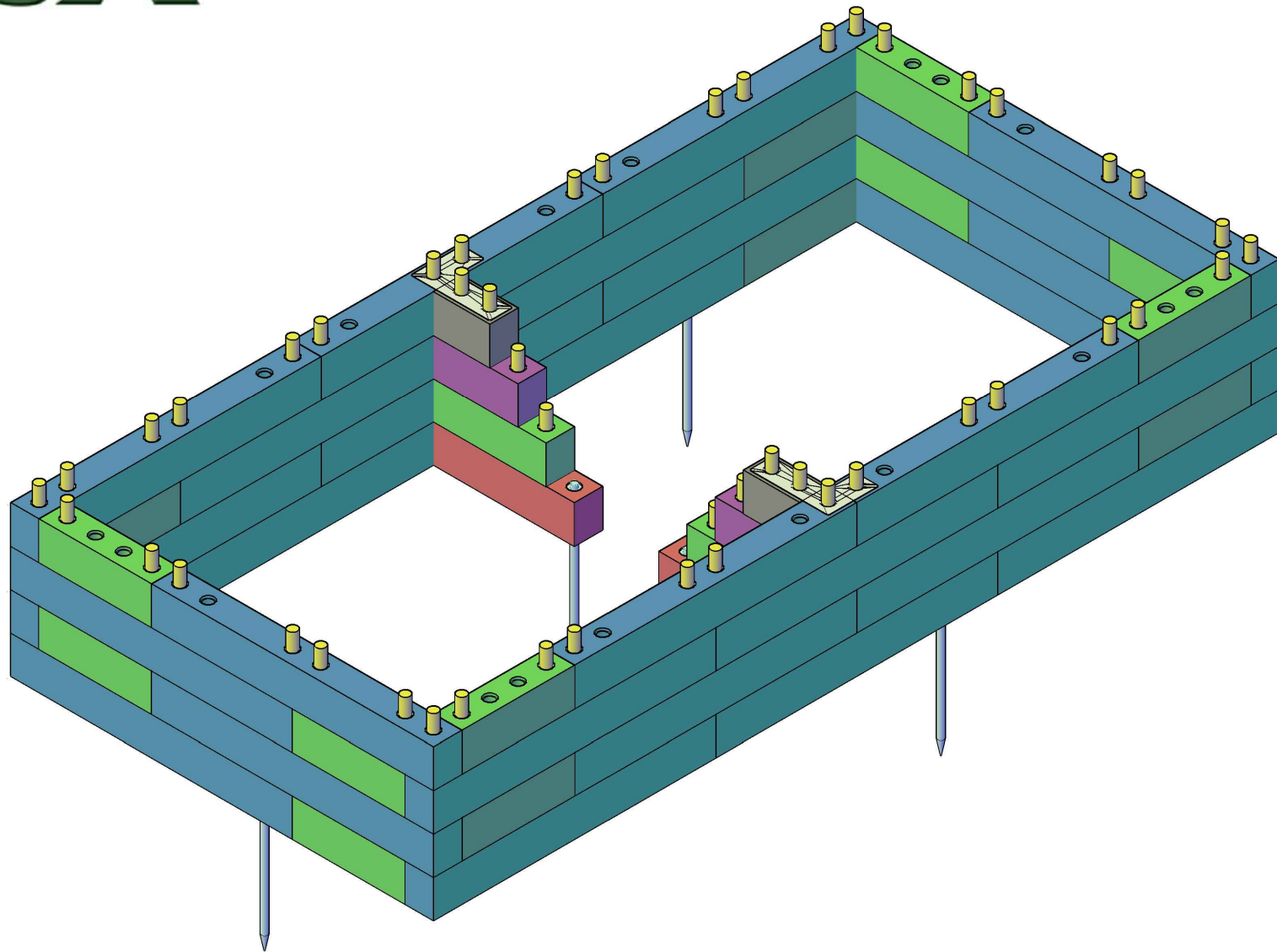



# WOOD BlocX

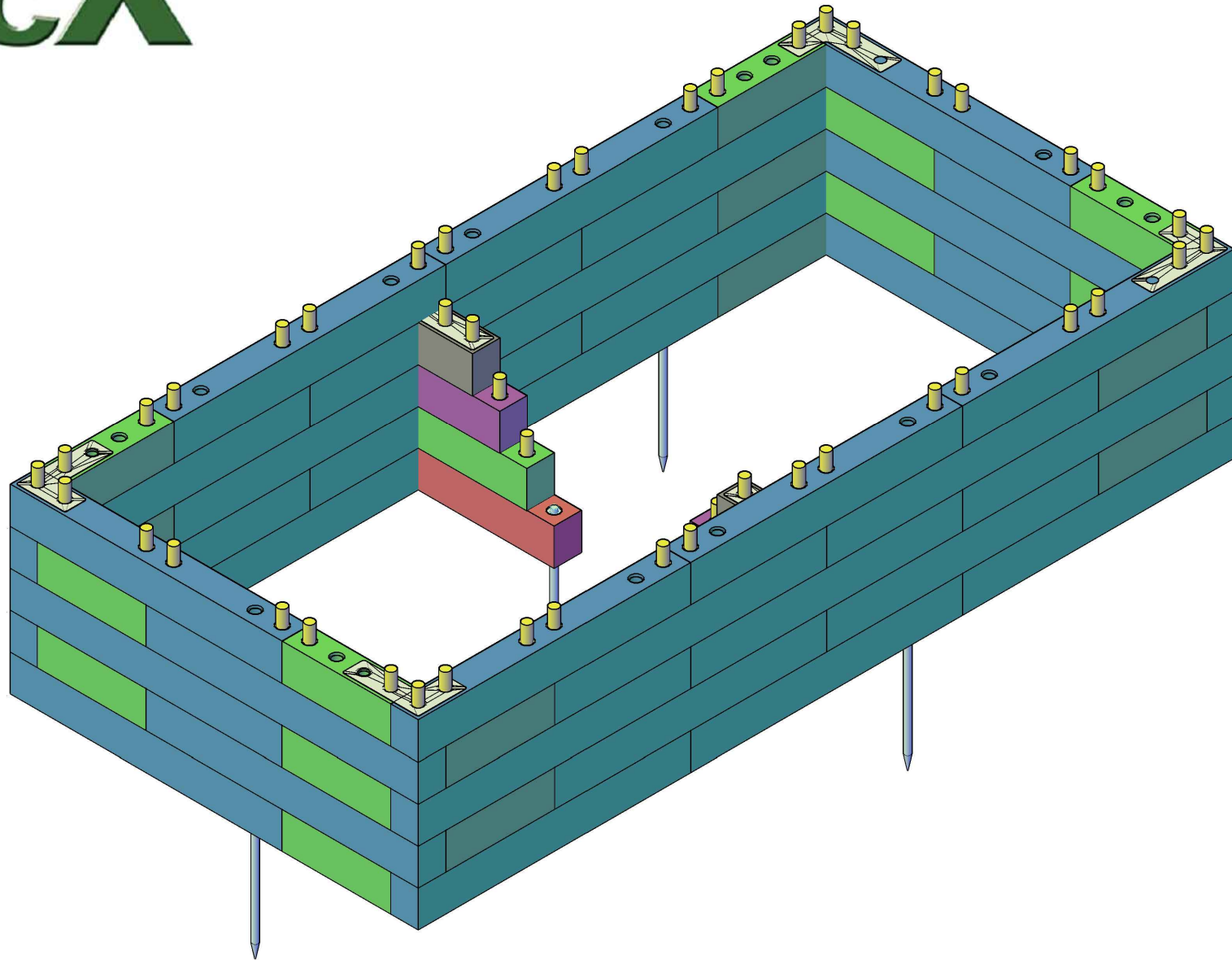

# WOOD BlocX

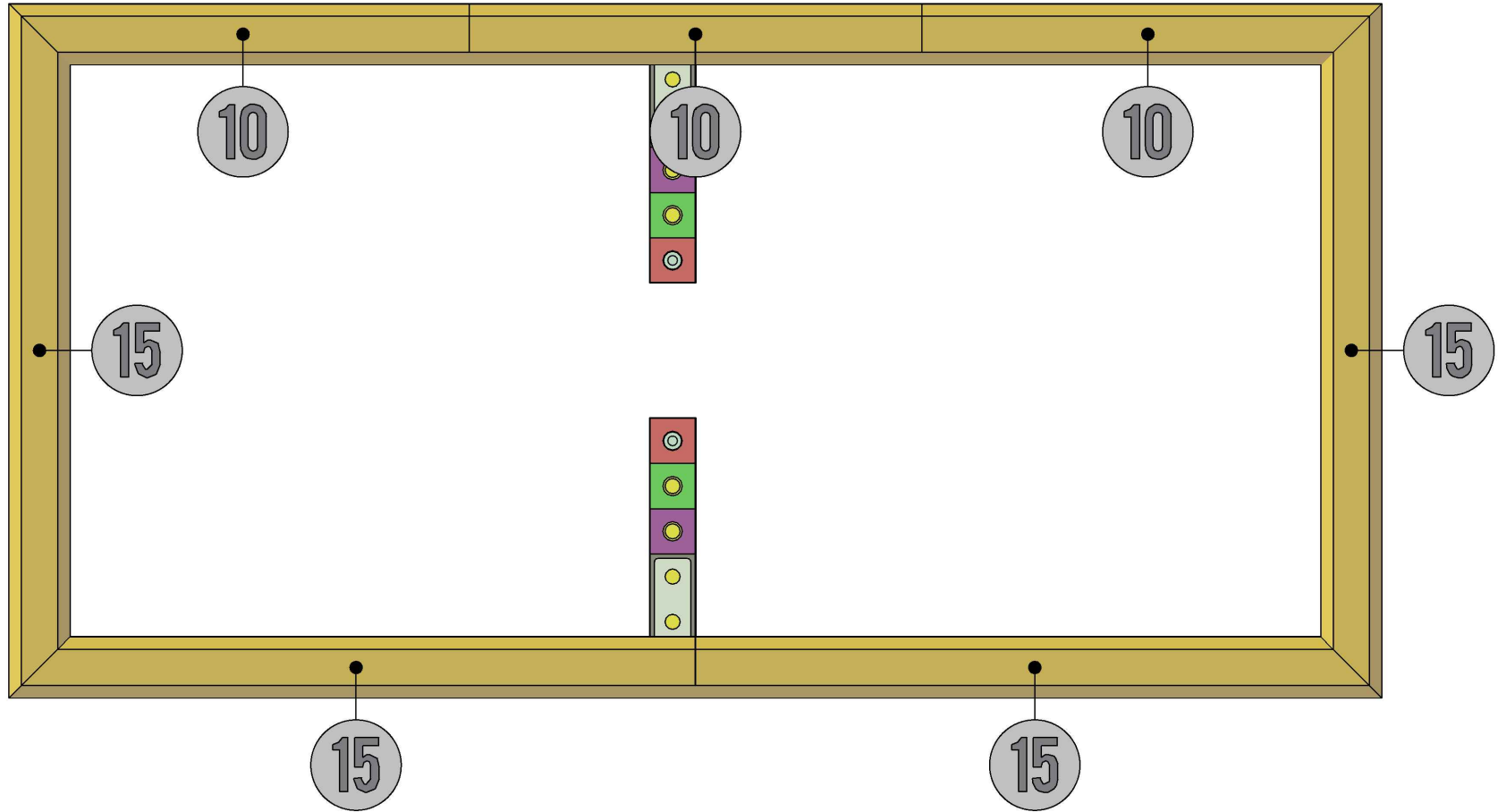

\*NUMBERS REPRESENT NUMBER OF HOLES IN CAPPING

# WOOD BlocX

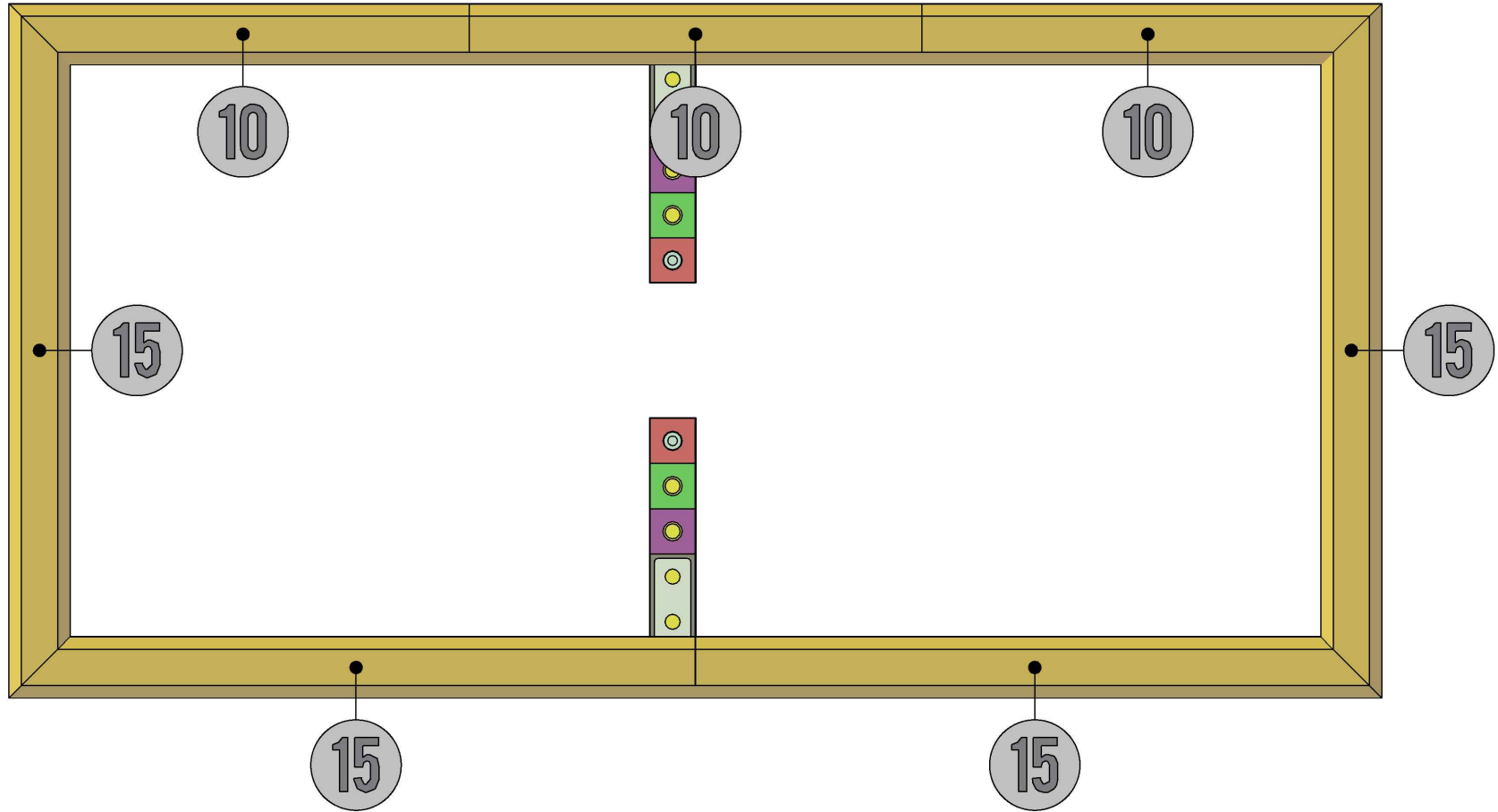

\*NUMBERS REPRESENT NUMBER OF HOLES IN CAPPING